

### Features

- Low  $R_{DS(on)}$  to Minimize Conduction Losses
- Low Capacitance to Minimize Driver Losses
- Optimized Gate Charge to Minimize Switching Losses

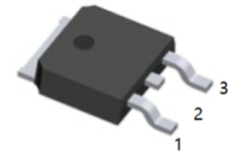

1.G 2.D 3.S  
TO-252(DPAK) top view

### Applications

- CPU Power Delivery
- DC-DC Converters
- Low Side Switching
- $V_{DS}(V) = 30V$
- $I_D = 88A$  ( $V_{GS} = 10V$ )
- $R_{DS(ON)} < 5.0m\Omega$  ( $V_{GS} = 10V$ )
- $R_{DS(ON)} < 7.4m\Omega$  ( $V_{GS} = 4.5V$ )

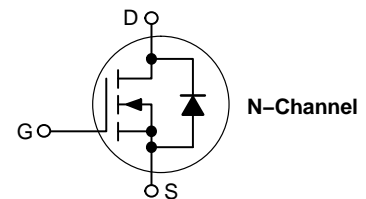

### MAXIMUM RATINGS ( $T_J = 25^\circ C$ unless otherwise noted)

Parameter			Symbol	Value	Unit
Drain-to-Source Voltage			$V_{DSS}$	30	V
Gate-to-Source Voltage			$V_{GS}$	$\pm 20$	V
Continuous Drain Current ( $R_{\theta JA}$ ) (Note 1)		$T_A = 25^\circ C$	$I_D$	17.4	A
		$T_A = 85^\circ C$		13.5	
Power Dissipation ( $R_{\theta JA}$ ) (Note 1)		$T_A = 25^\circ C$	$P_D$	2.65	W
Continuous Drain Current ( $R_{\theta JA}$ ) (Note 2)	Steady State	$T_A = 25^\circ C$	$I_D$	12.7	A
		$T_A = 85^\circ C$		9.8	
Power Dissipation ( $R_{\theta JA}$ ) (Note 2)		$T_A = 25^\circ C$	$P_D$	1.41	W
Continuous Drain Current ( $R_{\theta JC}$ ) (Note 1)		$T_C = 25^\circ C$	$I_D$	95	A
		$T_C = 85^\circ C$		73	
Power Dissipation ( $R_{\theta JC}$ ) (Note 1)		$T_C = 25^\circ C$	$P_D$	79	W
Pulsed Drain Current	$t_p = 10\mu s$	$T_A = 25^\circ C$	$I_{DM}$	175	A
Current Limited by Package		$T_A = 25^\circ C$	$I_{DmaxPkg}$	45	A
Operating Junction and Storage Temperature			$T_J, T_{stg}$	-55 to 175	$^\circ C$
Source Current (Body Diode)			$I_S$	55	A
Source Current (Body Diode) Pulsed $t_p = 20\mu s$			$I_{SM}$	175	A
Drain to Source dV/dt			dV/dt	6.0	V/ns
Single Pulse Drain-to-Source Avalanche Energy ( $V_{DD} = 24V, V_{GS} = 10V, L = 1.0mH, I_{L(pk)} = 24A, R_G = 25\Omega$ )			$E_{AS}$	288	mJ
Lead Temperature for Soldering Purposes (1/8" from case for 10 s)			$T_L$	260	$^\circ C$

### THERMAL RESISTANCE MAXIMUM RATINGS

Parameter	Symbol	Value	Unit
Junction-to-Case (Drain)	$R_{\theta JC}$	1.9	°C/W
Junction-to-TAB (Drain)	$R_{\theta JC-TAB}$	3.5	
Junction-to-Ambient – Steady State (Note 1)	$R_{\theta JA}$	56.6	
Junction-to-Ambient – Steady State (Note 2)	$R_{\theta JA}$	106.6	

### ELECTRICAL CHARACTERISTICS ( $T_J = 25^\circ\text{C}$ unless otherwise noted)

Parameter	Symbol	Test Condition	Min	Typ	Max	Unit	
Drain-to-Source Breakdown Voltage	$V_{(BR)DSS}$	$V_{GS} = 0\text{ V}, I_D = 250\ \mu\text{A}$	30			V	
Drain-to-Source Breakdown Voltage Temperature Coefficient	$V_{(BR)DSS}/T_J$			27		mV/°C	
Zero Gate Voltage Drain Current	$I_{DSS}$	$V_{GS} = 0\text{ V}, V_{DS} = 24\text{ V}$	$T_J = 25^\circ\text{C}$		1.0	$\mu\text{A}$	
			$T_J = 125^\circ\text{C}$		10		
Gate-to-Source Leakage Current	$I_{GSS}$	$V_{DS} = 0\text{ V}, V_{GS} = \pm 20\text{ V}$			$\pm 100$	nA	
Gate Threshold Voltage	$V_{GS(TH)}$	$V_{GS} = V_{DS}, I_D = 250\ \mu\text{A}$	1.5		2.5	V	
Negative Threshold Temperature Coefficient	$V_{GS(TH)}/T_J$			5.86		mV/°C	
Drain-to-Source On Resistance	$R_{DS(on)}$	$V_{GS} = 10\text{ to }11.5\text{ V}$	$I_D = 30\text{ A}$		4.3	5.0	m $\Omega$
			$I_D = 15\text{ A}$		4.2		
		$V_{GS} = 4.5\text{ V}$	$I_D = 30\text{ A}$		6.0	7.4	
			$I_D = 15\text{ A}$		5.8		
Forward Transconductance	$g_{FS}$	$V_{DS} = 15\text{ V}, I_D = 15\text{ A}$		17		S	
Input Capacitance	$C_{iss}$	$V_{GS} = 0\text{ V}, f = 1.0\text{ MHz}, V_{DS} = 12\text{ V}$		2865		pF	
Output Capacitance	$C_{oss}$			610			
Reverse Transfer Capacitance	$C_{riss}$			338			
Total Gate Charge	$Q_{G(TOT)}$	$V_{GS} = 4.5\text{ V}, V_{DS} = 15\text{ V}, I_D = 30\text{ A}$		20.5	26	nC	
Threshold Gate Charge	$Q_{G(TH)}$			4.05			
Gate-to-Source Charge	$Q_{GS}$			8.28			
Gate-to-Drain Charge	$Q_{GD}$			8.36			
Total Gate Charge	$Q_{G(TOT)}$	$V_{GS} = 11.5\text{ V}, V_{DS} = 15\text{ V}, I_D = 30\text{ A}$		48		nC	
Turn-On Delay Time	$t_{d(on)}$	$V_{GS} = 4.5\text{ V}, V_{DS} = 15\text{ V}, I_D = 15\text{ A}, R_G = 3.0\ \Omega$		17.2		ns	
Rise Time	$t_r$			20.3			
Turn-Off Delay Time	$t_{d(off)}$			20.8			
Fall Time	$t_f$			8.0			
Turn-On Delay Time	$t_{d(on)}$	$V_{GS} = 11.5\text{ V}, V_{DS} = 15\text{ V}, I_D = 15\text{ A}, R_G = 3.0\ \Omega$		10.8		ns	
Rise Time	$t_r$			20.5			
Turn-Off Delay Time	$t_{d(off)}$			30.8			
Fall Time	$t_f$			4.4			

### ELECTRICAL CHARACTERISTICS ( $T_J = 25^\circ\text{C}$ unless otherwise noted) (continued)

Parameter	Symbol	Test Condition	Min	Typ	Max	Unit	
Forward Diode Voltage	$V_{SD}$	$V_{GS} = 0\text{ V},$ $I_S = 30\text{ A}$	$T_J = 25^\circ\text{C}$		0.87	1.2	V
			$T_J = 125^\circ\text{C}$		0.76		
Reverse Recovery Time	$t_{RR}$	$V_{GS} = 0\text{ V},$ $dI_S/dt = 100\text{ A}/\mu\text{s},$ $I_S = 30\text{ A}$		25.7		ns	
Charge Time	$t_a$			13.1			
Discharge Time	$t_b$			12.6			
Reverse Recovery Time	$Q_{RR}$			18			
Source Inductance	$L_S$	$T_A = 25^\circ\text{C}$		2.49		nH	
Drain Inductance, DPAK	$L_D$			0.0164			
Drain Inductance, IPAK	$L_D$			1.88			
Gate Inductance	$L_G$			3.46			
Gate Resistance	$R_G$			0.8			$\Omega$

Product parametric performance is indicated in the Electrical Characteristics for the listed test conditions, unless otherwise noted. Product performance may not be indicated by the Electrical Characteristics if operated under different conditions.

3. Pulse Test: Pulse Width  $\leq 300\ \mu\text{s}$ , Duty Cycle  $\leq 2\%$ .

4. Switching characteristics are independent of operating junction temperatures.

TYPICAL PERFORMANCE CURVES

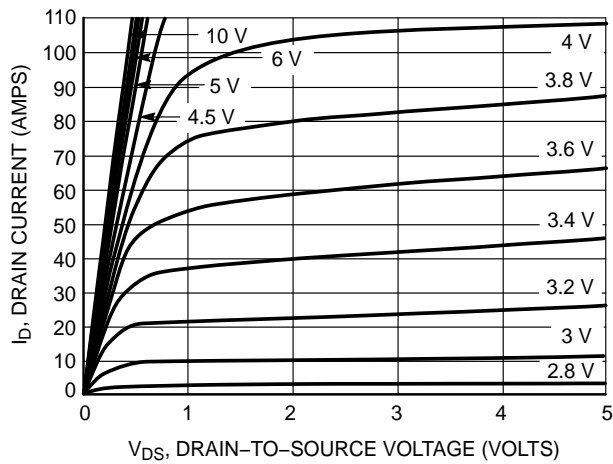

Figure 1. On-Region Characteristics

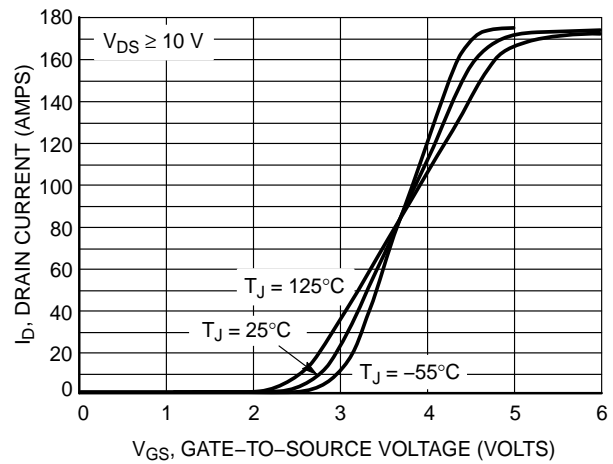

Figure 2. Transfer Characteristics

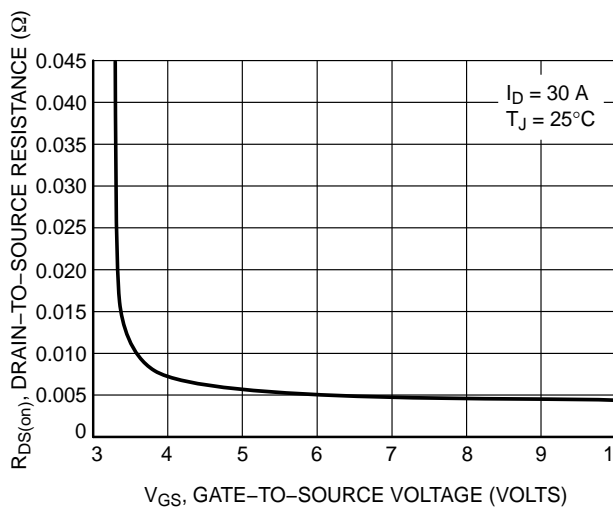

Figure 3. On-Resistance vs. Gate-to-Source Voltage

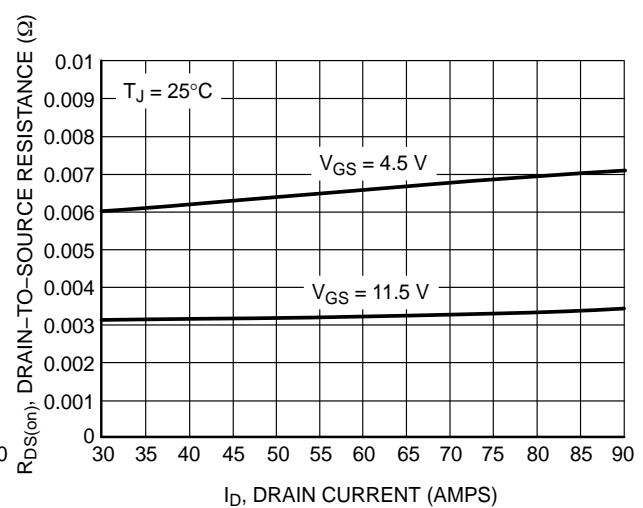

Figure 4. On-Resistance vs. Drain Current and Gate Voltage

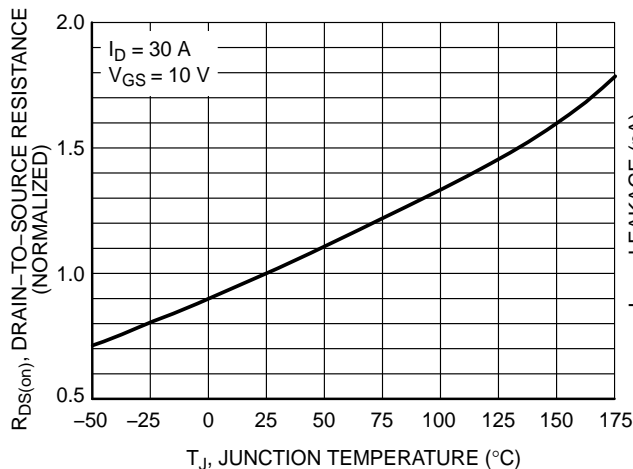

Figure 5. On-Resistance Variation with Temperature

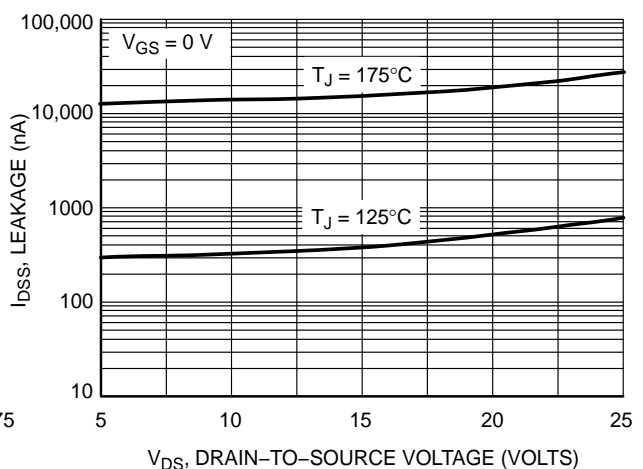

Figure 6. Drain-to-Source Leakage Current vs. Drain Voltage

TYPICAL PERFORMANCE CURVES

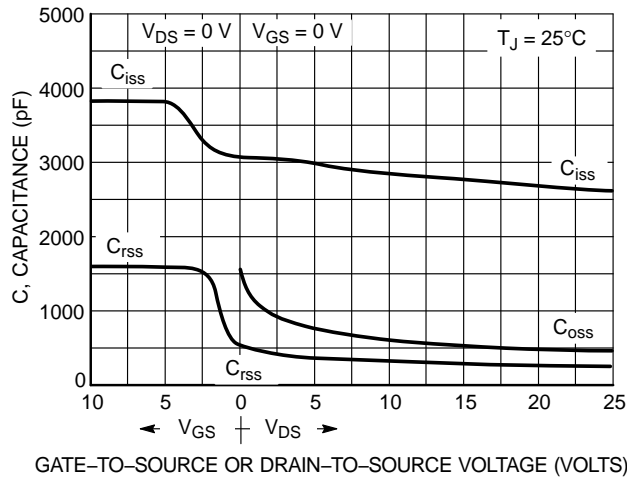

Figure 7. Capacitance Variation

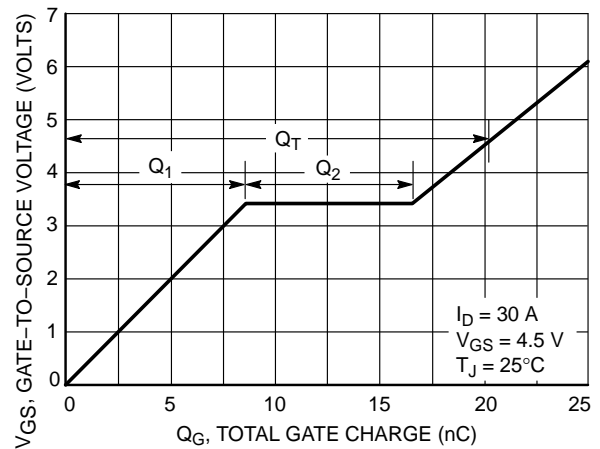

Figure 8. Gate-To-Source and Drain-To-Source Voltage vs. Total Charge

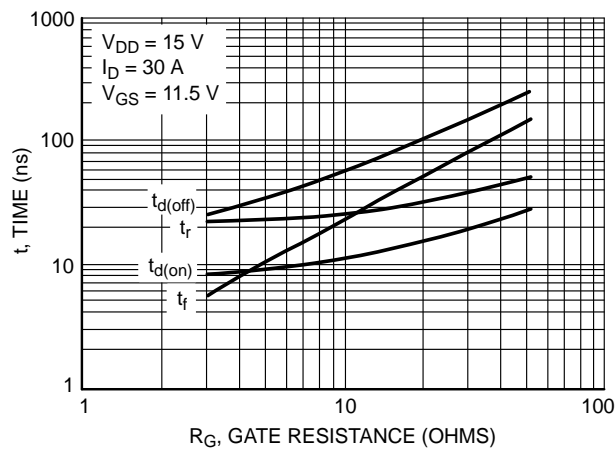

Figure 9. Resistive Switching Time Variation vs. Gate Resistance

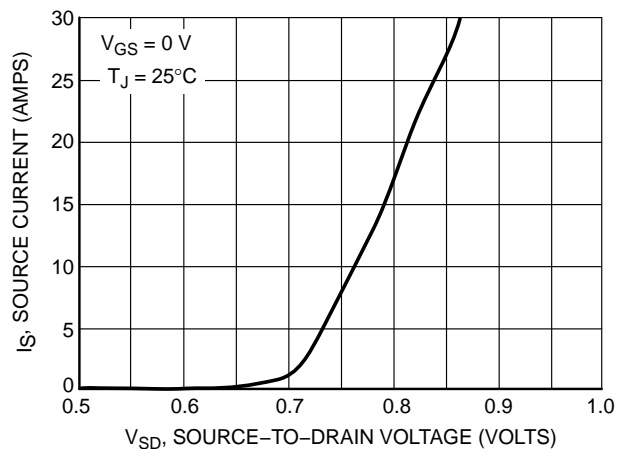

Figure 10. Diode Forward Voltage vs. Current

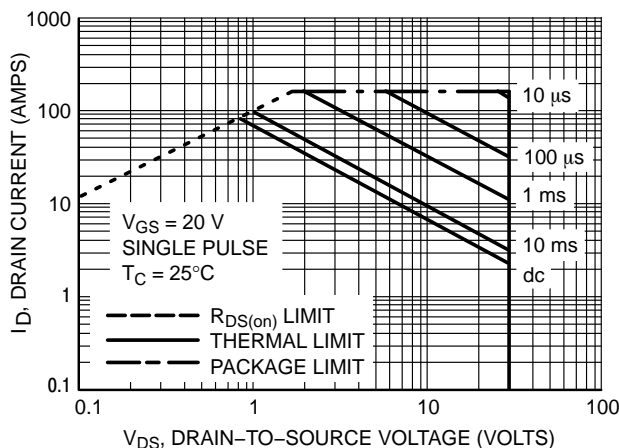

Figure 11. Maximum Rated Forward Biased Safe Operating Area

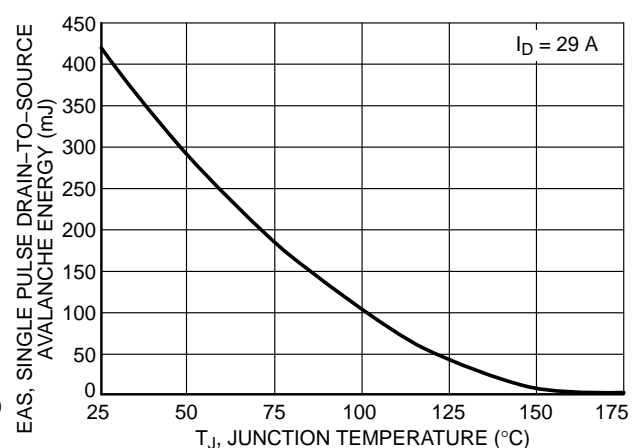

Figure 12. Maximum Avalanche Energy vs. Starting Junction Temperature

TYPICAL PERFORMANCE CURVES

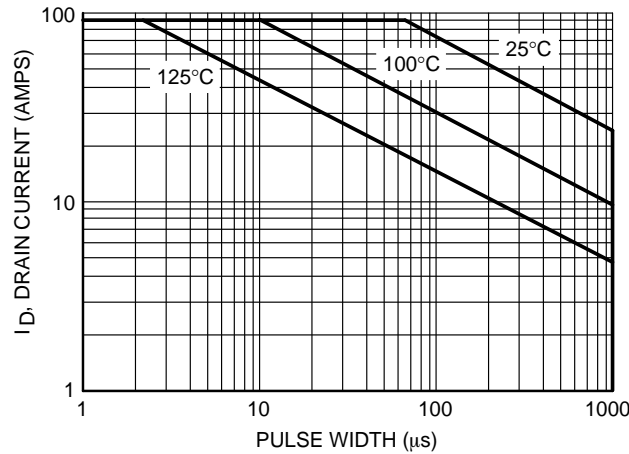

Figure 13. Avalanche Characteristics

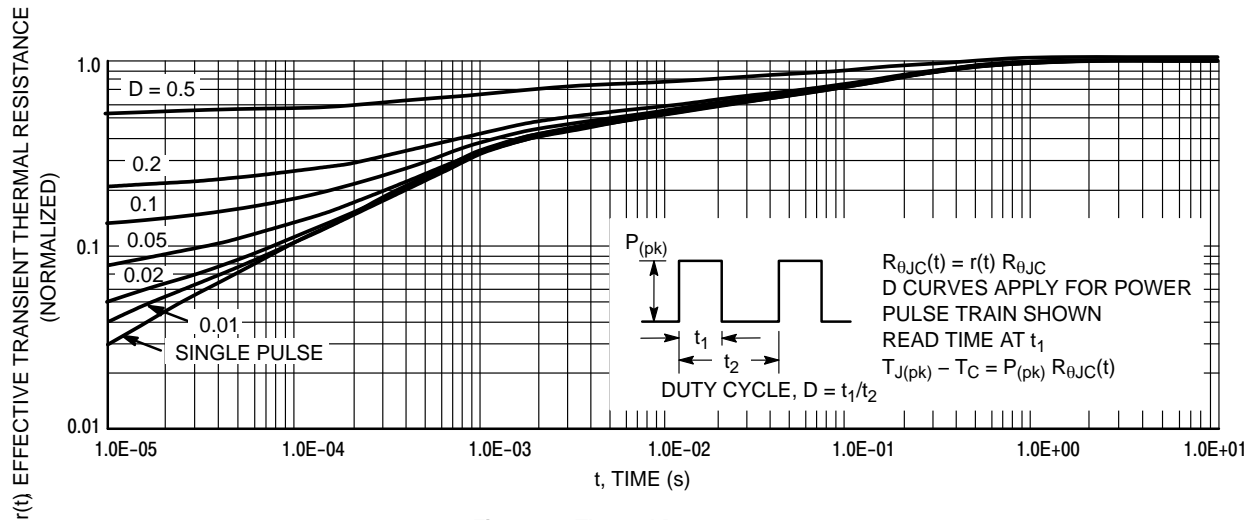
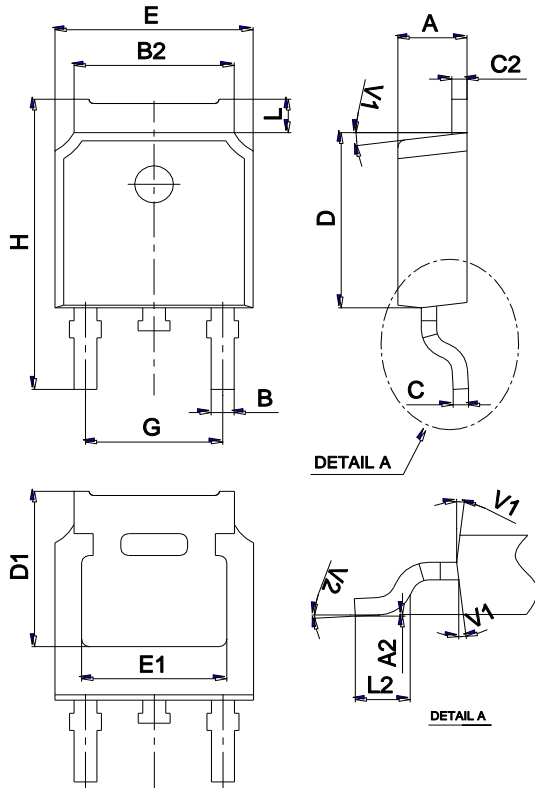

Figure 14. Thermal Response

Package Mechanical Data TO-252



Ref.	Dimensions					
	Millimeters			Inches		
	Min.	Typ.	Max.	Min.	Typ.	Max.
A	2.10		2.50	0.083		0.098
A2	0		0.10	0		0.004
B	0.66		0.86	0.026		0.034
B2	5.18		5.48	0.202		0.216
C	0.40		0.60	0.016		0.024
C2	0.44		0.58	0.017		0.023
D	5.90		6.30	0.232		0.248
D1	5.30REF			0.209REF		
E	6.40		6.80	0.252		0.268
E1	4.63			0.182		
G	4.47		4.67	0.176		0.184
H	9.50		10.70	0.374		0.421
L	1.09		1.21	0.043		0.048
L2	1.35		1.65	0.053		0.065
V1		7°			7°	
V2	0°		6°	0°		6°

Marking

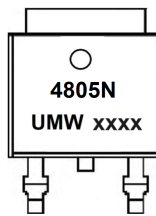

Ordering information

Order code	Package	Baseqty	Deliverymode
UMW NTD4805NT4G	TO-252	2500	Tape and reel