

### Applications

- High Frequency Synchronous Buck Converters for Computer Processor Power

### Benefits

- Very Low  $R_{DS(on)}$  at 4.5V  $V_{GS}$
- Ultra - Low Gate Impedance
- Fully Characterized Avalanche Voltage and Current
- Lead-Free

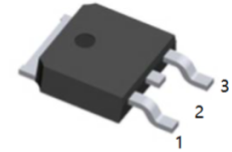

1.G 2.D 3.S  
TO-252(DPAK) top view

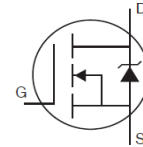

- $V_{DSS} = 30V$
- $R_{DS(on) max} = 9.5m\Omega$
- $Q_g = 9.6nC$

### Absolute Maximum Ratings

Symbol	Parameter	Max.	Units
$V_{DS}$	Drain -to-Source Voltage	30	V
$V_{GS}$	Gate-to-Source Voltage	$\pm 20$	V
$I_D @ T_C = 25^\circ C$	Continuous Drain Current, $V_{GS} @ 10V$	56 <sup>④</sup>	A
$I_D @ T_C = 100^\circ C$	Continuous Drain Current, $V_{GS} @ 10V$	39 <sup>④</sup>	
$I_{DM}$	Pulsed Drain Current <sup>①</sup>	220	
$P_D @ T_C = 25^\circ C$	Maximum Power Dissipation	50	W
$P_D @ T_C = 100^\circ C$	Maximum Power Dissipation	25	W
	Linear Derating Factor	0.33	W/°C
$T_J$ $T_{STG}$	Operating Junction and Storage Temperature Range	-55 to + 175	°C
	Soldering Temperature, for 10 seconds (1.6mm from case)	300	

### Thermal Resistance

Symbol	Parameter	Typ.	Max.	Units
$R_{\theta JC}$	Junction-to-Case		3.0	°C/W
$R_{\theta JA}$	Junction-to-Ambient ( PCB Mount) <sup>⑤</sup>		50	
$R_{\theta JA}$	Junction-to-Ambient		110	

**Static @ T<sub>J</sub> = 25°C (unless otherwise specified)**
**30V N -Channel MOSFET**

	Parameter	Min.	Typ.	Max.	Units	Conditions
V <sub>(BR)DSS</sub>	Drain-to-Source Breakdown Voltage	30			V	V <sub>GS</sub> = 0V, I <sub>D</sub> = 250μA
ΔV <sub>(BR)DSS</sub> /ΔT <sub>J</sub>	Breakdown Voltage Temp. Coefficient			0.023	V/°C	Reference to 25°C, I <sub>D</sub> = 1mA
R <sub>DS(on)</sub>	Static Drain-to-Source On-Resistance		7.5	9.5	mΩ	V <sub>GS</sub> = 10V, I <sub>D</sub> = 15A ③
			10	12.5		V <sub>GS</sub> = 4.5V, I <sub>D</sub> = 12A ③
V <sub>GS(th)</sub>	Gate Threshold Voltage	1.0	1.70	2.50	V	V <sub>DS</sub> = V <sub>GS</sub> , I <sub>D</sub> = 25μA
ΔV <sub>GS(th)</sub> /ΔT <sub>J</sub>	Gate Threshold Voltage Temp. Coefficient		-5.0		mV/°C	
I <sub>DSS</sub>	Drain-to-Source Leakage Current			1.0	μA	V <sub>DS</sub> = 24V, V <sub>GS</sub> = 0V
				150		V <sub>DS</sub> = 24V, V <sub>GS</sub> = 0V, T <sub>J</sub> = 125°C
I <sub>GSS</sub>	Gate-to-Source Forward Leakage			100	nA	V <sub>GS</sub> = 20V
	Gate-to-Source Reverse Leakage			-100		V <sub>GS</sub> = -20V
gfs	Forward Trans conductance	71			S	V <sub>DS</sub> = 15V, I <sub>D</sub> = 12A
Q <sub>g</sub>	Total Gate Charge		9.6	14	nC	V <sub>DS</sub> = 15V V <sub>GS</sub> = 4.5V I <sub>D</sub> = 12A See Fig. 16
Q <sub>gs1</sub>	Pre-V <sub>th</sub> Gate-to-Source Charge		2.6			
Q <sub>gs2</sub>	Post-V <sub>th</sub> Gate-to-Source Charge		0.90			
Q <sub>gd</sub>	Gate-to-Drain Charge		3.5			
Q <sub>godr</sub>	Gate Charge Overdrive		2.6			
Q <sub>sw</sub>	Switch Charge (Q <sub>gs2</sub> + Q <sub>gd</sub> )		4.4			
Q <sub>oss</sub>	Output Charge		5.8		nC	V <sub>DS</sub> = 15V, V <sub>GS</sub> = 0V
t <sub>d(on)</sub>	Turn-On Delay Time		8.0		ns	V <sub>DD</sub> = 16V, V <sub>GS</sub> = 4.5V ③ I <sub>D</sub> = 12A Clamped Inductive Load
t <sub>r</sub>	Rise Time		11			
t <sub>d(off)</sub>	Turn-Off Delay Time		12			
t <sub>f</sub>	Fall Time		3.3			
C <sub>iss</sub>	Input Capacitance		1150		pF	V <sub>GS</sub> = 0V V <sub>DS</sub> = 15V f = 1.0MHz
C <sub>oss</sub>	Output Capacitance		260			
C <sub>rss</sub>	Reverse Transfer Capacitance		120			

**Avalanche Characteristics**

	Parameter	Max.	Units
E <sub>AS</sub>	Single Pulse Avalanche Energy ②	42	mJ
I <sub>AR</sub>	Avalanche Current ①	12	A
E <sub>AR</sub>	Repetitive Avalanche Energy ①	5.0	mJ

**Diode Characteristics**

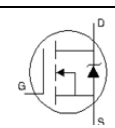
	Parameter	Min.	Typ.	Max.	Units	Conditions
I <sub>S</sub>	Continuous Source Current (Body Diode)			56④	A	MOSFET symbol showing the integral reverse p-n junction diode. 
I <sub>SM</sub>	Pulsed Source Current (Body Diode) ①			220		
V <sub>SD</sub>	Diode Forward Voltage			1.0	V	T <sub>J</sub> = 25°C, I <sub>S</sub> = 12A, V <sub>GS</sub> = 0V ③
t <sub>rr</sub>	Reverse Recovery Time		25	38	ns	T <sub>J</sub> = 25°C, I <sub>F</sub> = 12A, V <sub>DS</sub> = 15V
Q <sub>rr</sub>	Reverse Recovery Charge		17	26	nC	di/dt = 100A/μs ③
t <sub>on</sub>	Forward Turn-On Time	Intrinsic turn-on time is negligible (turn-on is dominated by L <sub>S</sub> +L <sub>D</sub> )				

**Notes:**

- ① Repetitive rating; pulse width limited by max. junction temperature
- ② starting T<sub>J</sub> = 25°C, L = 0.58mH, R<sub>G</sub> = 25Ω, I<sub>AS</sub> = 12A.
- ③ Pulse width ≤ 400μs; duty cycle ≤ 2%.
- ④ Calculated continuous current based on maximum allowable junction temperature. Package limitation current is 30A.

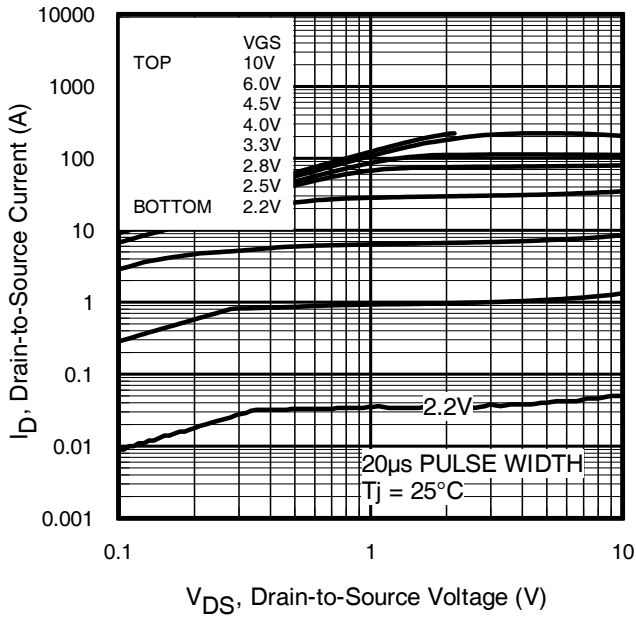

Fig. 1 Typical Output Characteristics

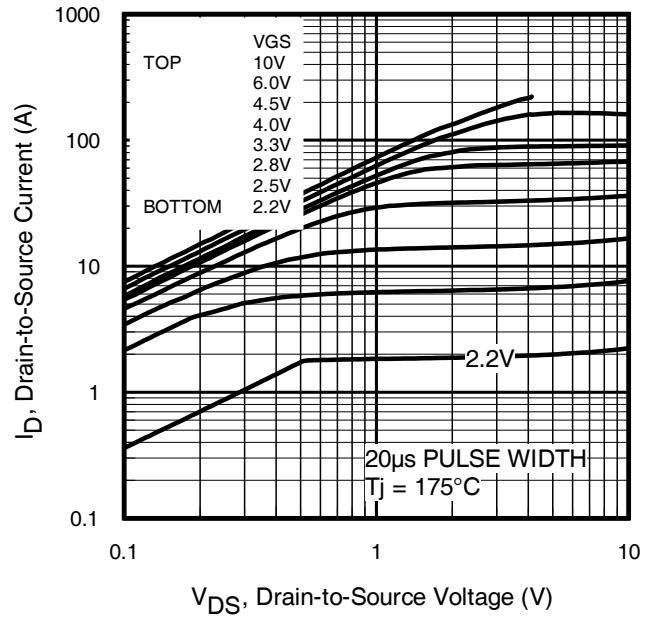

Fig. 2 Typical Output Characteristics

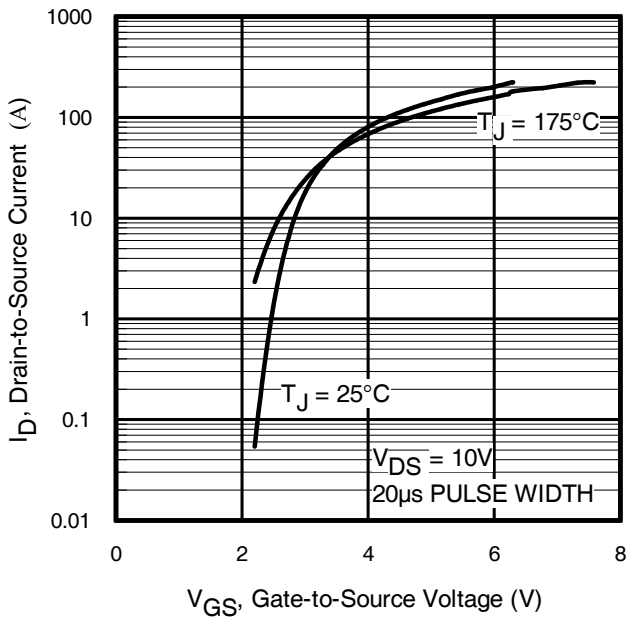

Fig. 3 Typical Transfer Characteristics

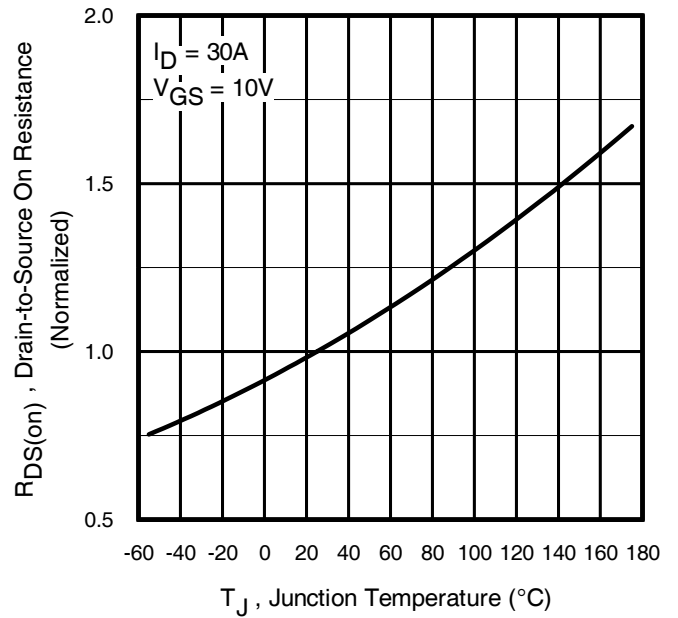

Fig. 4 Normalized On-Resistance vs. Temperature

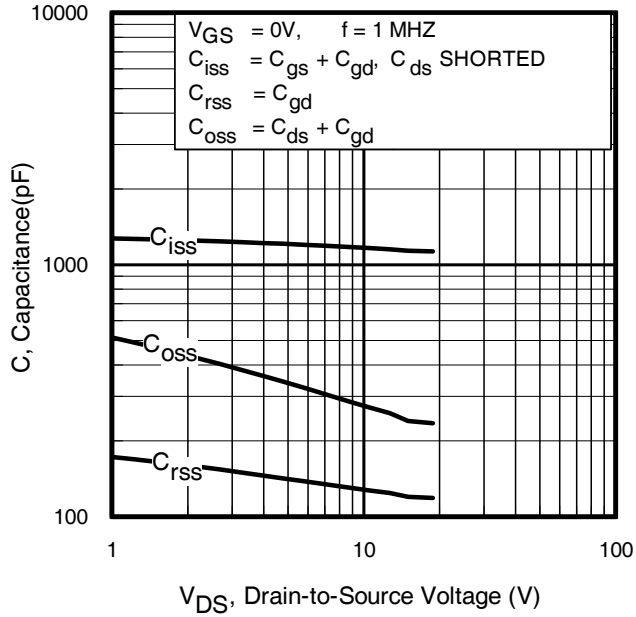

Fig 5. Typical Capacitance vs. Drain-to-Source Voltage

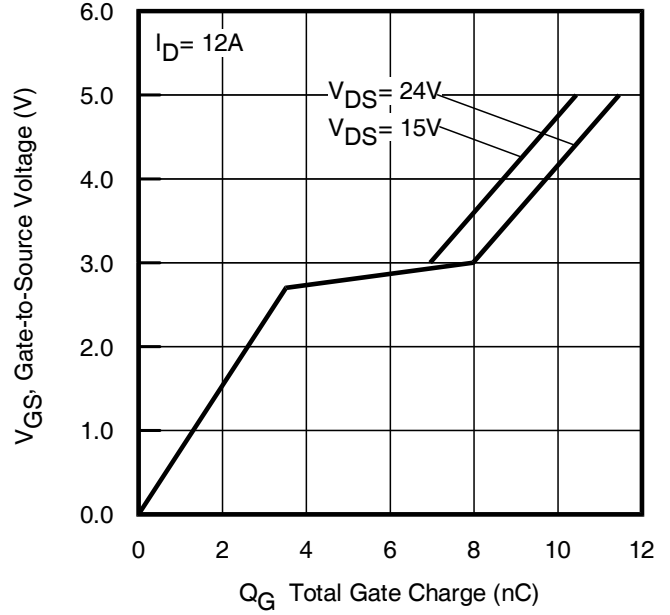

Fig 6. Typical Gate Charge vs. Gate-to-Source Voltage

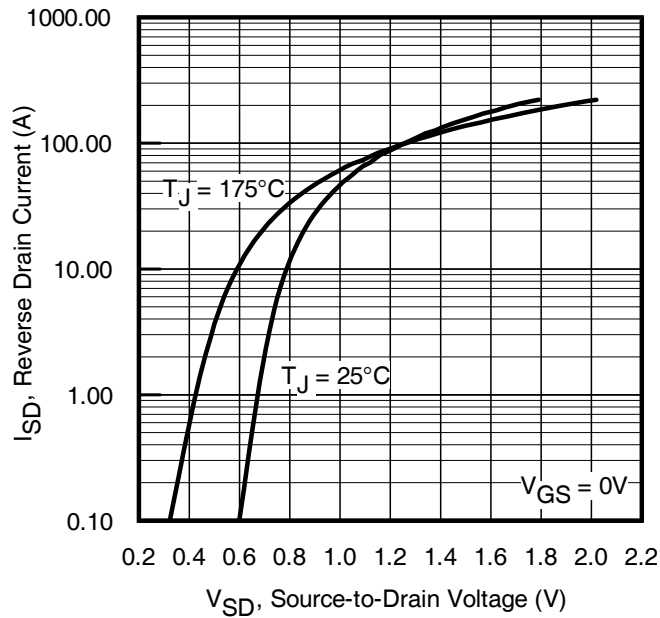

Fig. 7 Typical Source-to-Drain Diode Forward Voltage

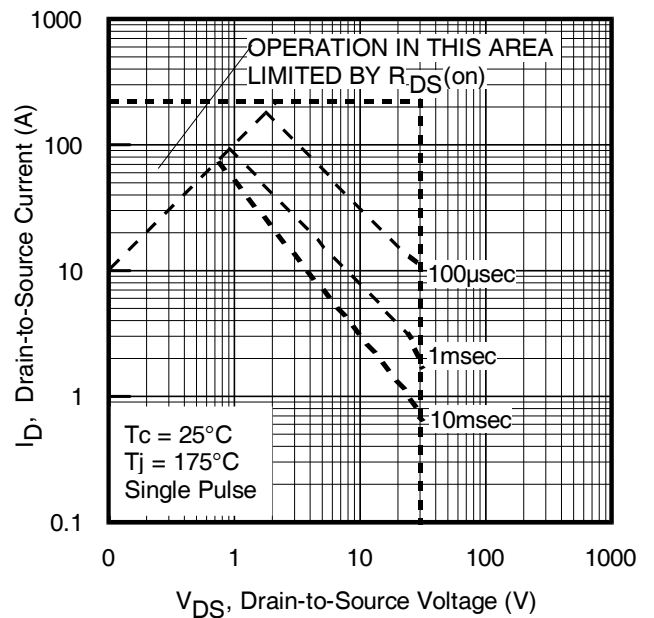

Fig 8. Maximum Safe Operating Area

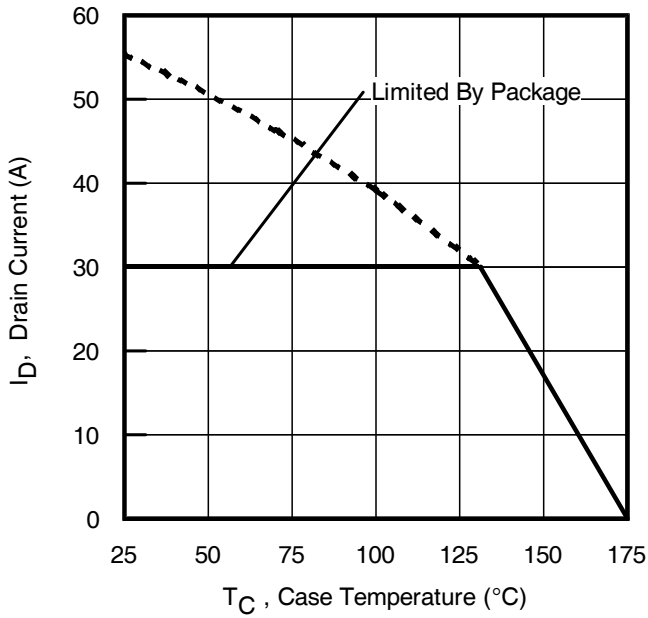

Fig 9. Maximum Drain Current vs. Case Temperature

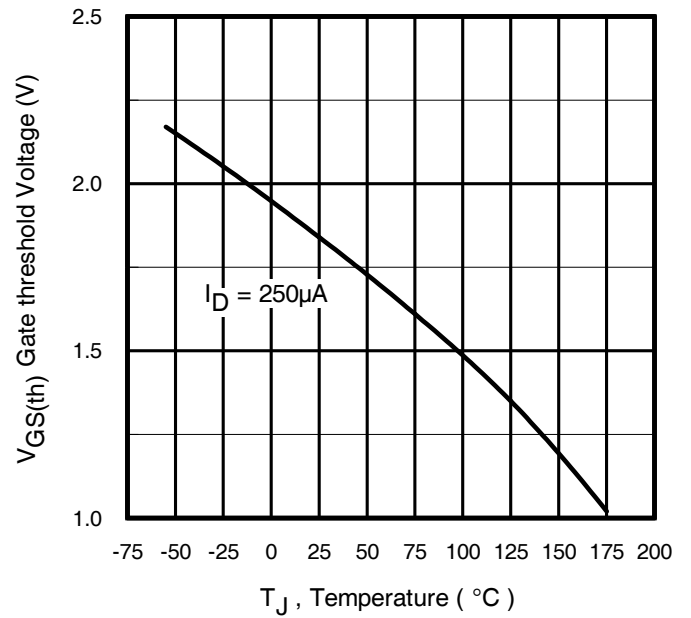

Fig 10. Threshold Voltage vs. Temperature

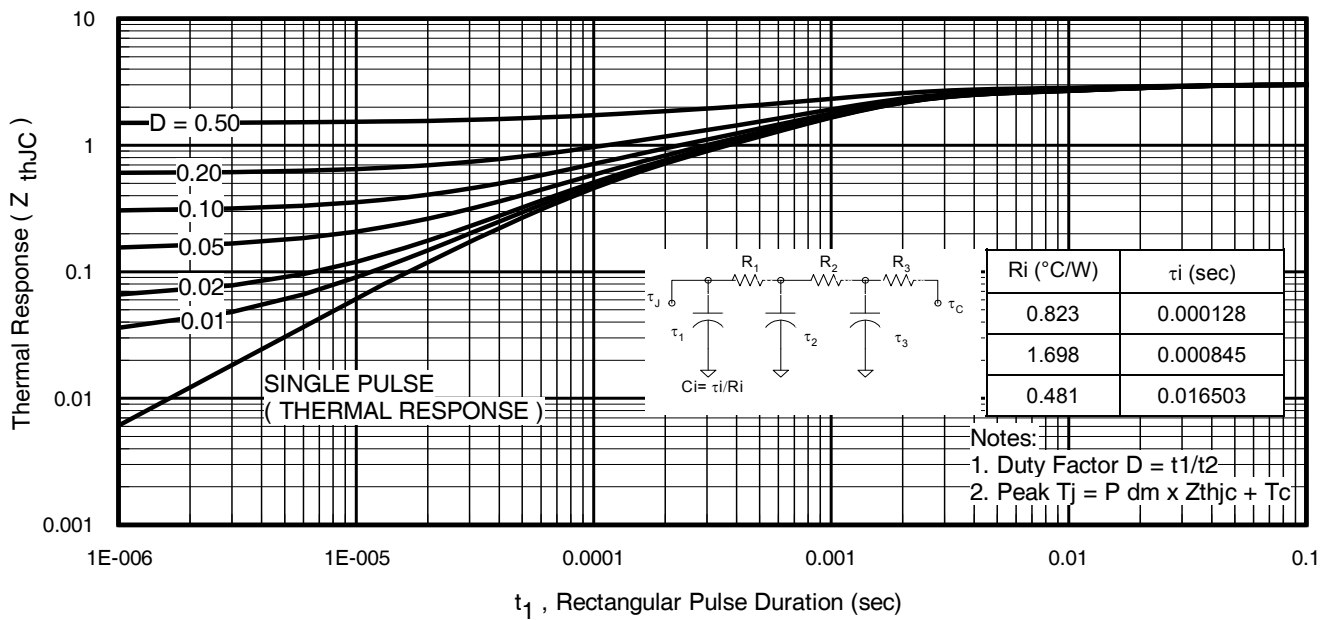

Fig 11. Maximum Effective Transient Thermal Impedance, Junction-to-Case

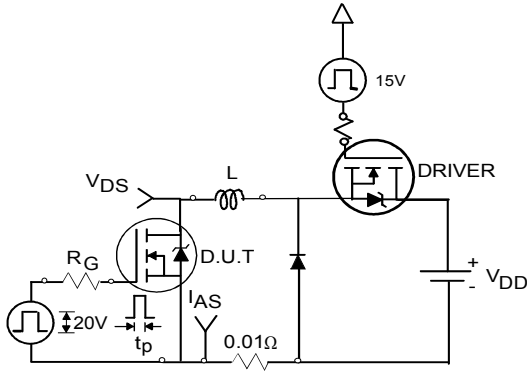

Fig 12a. Unclamped Inductive Test Circuit

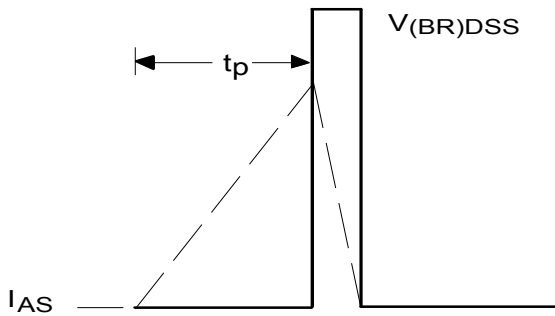

Fig 12b. Unclamped Inductive Waveforms

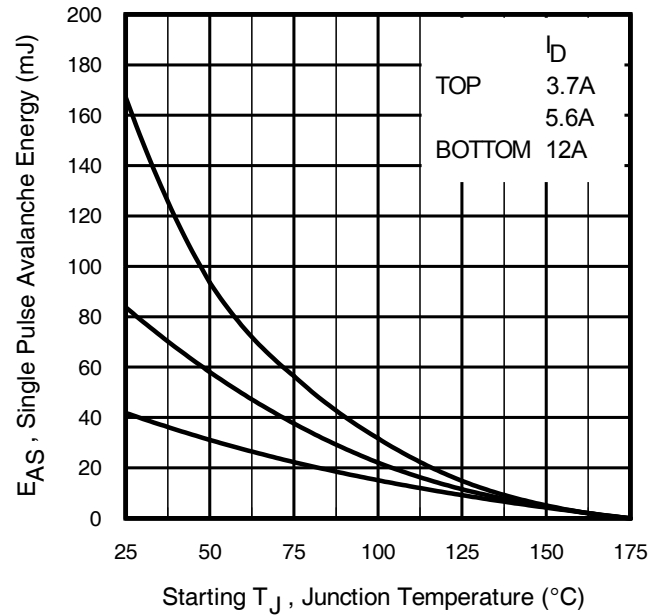

Fig 12c. Maximum Avalanche Energy vs. Drain Current

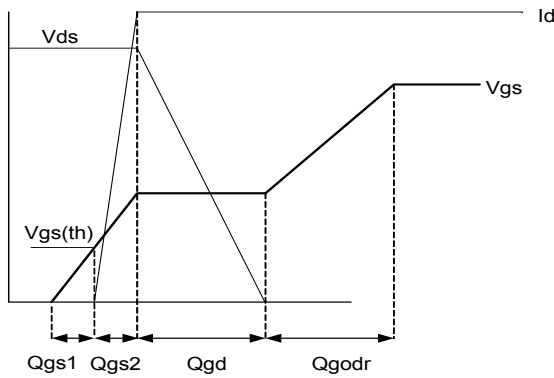

Fig 13a. Gate Charge Waveform

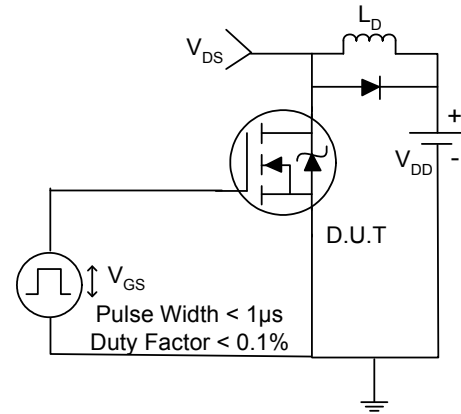

Fig 14a. Switching Time Test Circuit

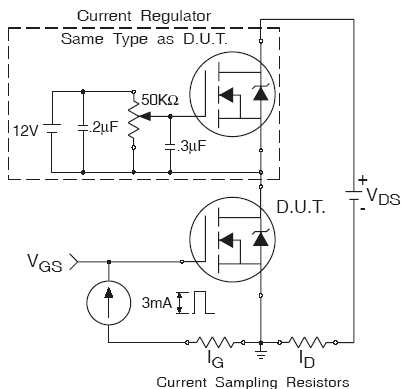

Fig 13b. Gate Charge Test Circuit

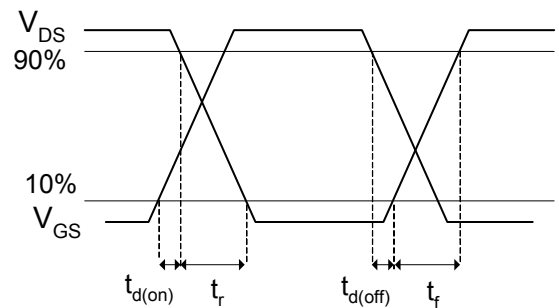
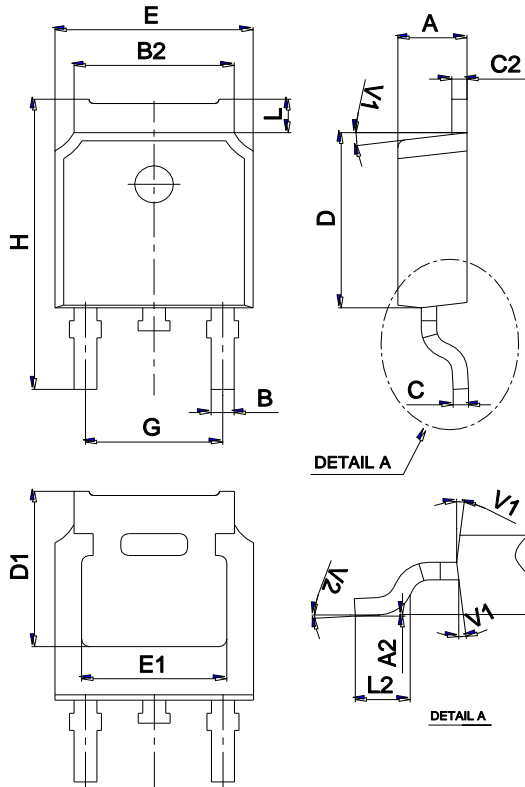

Fig 14b. Switching Time Waveforms

Package Mechanical Data TO-252



Ref.	Dimensions					
	Millimeters			Inches		
	Min.	Typ.	Max.	Min.	Typ.	Max.
A	2.10		2.50	0.083		0.098
A2	0		0.10	0		0.004
B	0.66		0.86	0.026		0.034
B2	5.18		5.48	0.202		0.216
C	0.40		0.60	0.016		0.024
C2	0.44		0.58	0.017		0.023
D	5.90		6.30	0.232		0.248
D1	5.30REF			0.209REF		
E	6.40		6.80	0.252		0.268
E1	4.63			0.182		
G	4.47		4.67	0.176		0.184
H	9.50		10.70	0.374		0.421
L	1.09		1.21	0.043		0.048
L2	1.35		1.65	0.053		0.065
V1		7°			7°	
V2	0°		6°	0°		6°

Marking

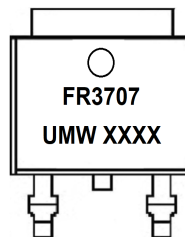

Ordering information

Order code	Package	Baseqty	Deliverymode
UMW IRFR3707ZTR	TO-252	2500	Tape and reel