

Description

The UBD32C05L01 of transient voltage suppressors are designed to protect low voltage, state-of-the-art CMOS semiconductors from transients caused by electrostatic discharge (ESD), cable discharge events (CDE), lightning and other induced voltage surges. The "flow-thru" design minimizes trace inductance and reduces voltage overshoot associated with ESD events. The low clamping voltage of the device minimizes the stress on the protected IC.

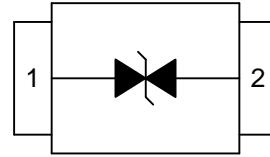

Features

- IEC61000-4-2 ESD 15KV Air, 8KV contact compliance
- SOD-323 surface mount package
- Protects one I/O line
- Working voltage: 5V
- Low leakage current
- Low operating and clamping voltages
- Solder reflow temperature: Pure Tin-Sn, 260~270°C

Applications

- High-speed data lines
- Microprocessor based equipment
- LAN / WAN equipment
- Desktops PC and servers
- Notebook, Laptop and Palmtop computers
- Portable instrumentation
- Peripherals
- Universal serial bus (USB) port protection

Maximum Ratings

Rating	Symbol	Value	Unit
Peak pulse current (tp=8/20µs waveform)	I _{PP}	3	A
ESD voltage (Contact discharge)	V _{ESD}	±8	kV
ESD voltage (Air discharge)		±15	
Storage & operating temperature range	T _{STG} , T _J	-55~+150	°C

Electrical Characteristics (T_J=25°C)

Parameter	Symbol	Condition	Min.	Typ.	Max.	Unit
Reverse stand-off voltage	V _{RWM}				5	V
Reverse breakdown voltage	V _{BR}	I _{BR} =1mA	6			V
Reverse leakage current	I _R	V _R =5V			1	μA
Clamping voltage (tp=8/20μs)	V _C	I _{PP} =1A			11	V
Clamping voltage (tp=8/20μs)	V _C	I _{PP} =3A			20	V
Off state junction capacitance	C _J	0Vdc,f=1MHz		0.4		pF

Typical Characteristics Curves

Figure 1. Power Derating Curve

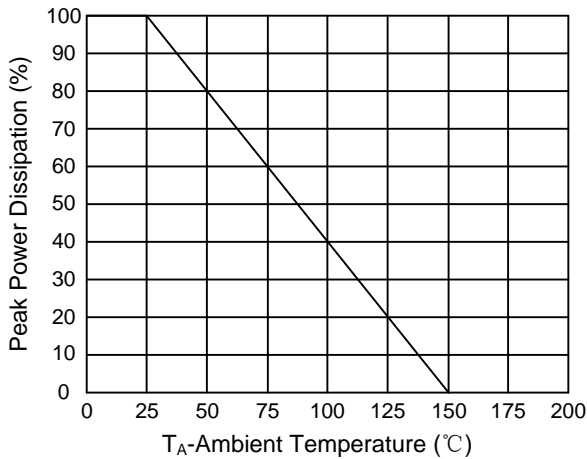

Figure 2. Pulse Waveform

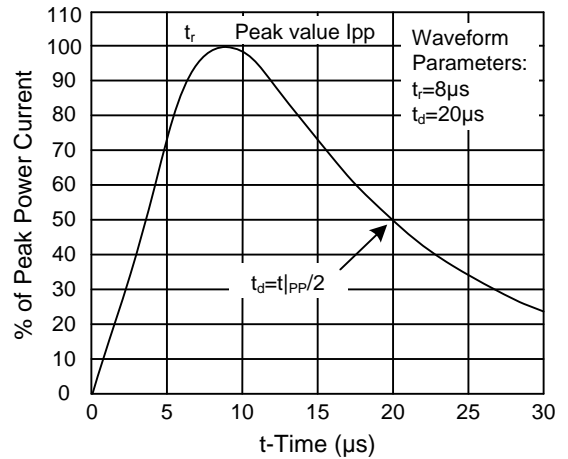

Figure 3. Normalized Capacitance vs. Reverse Voltage

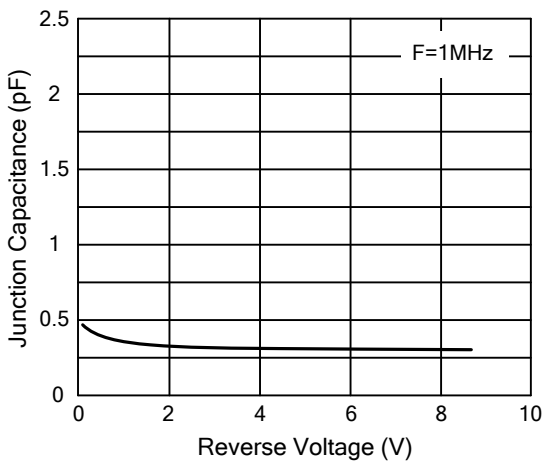
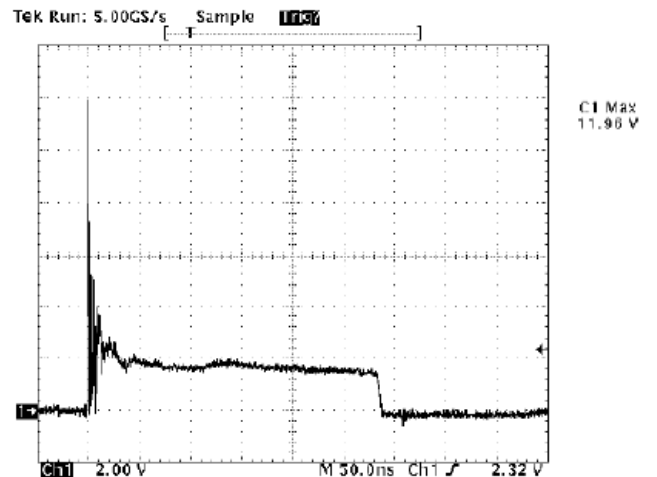
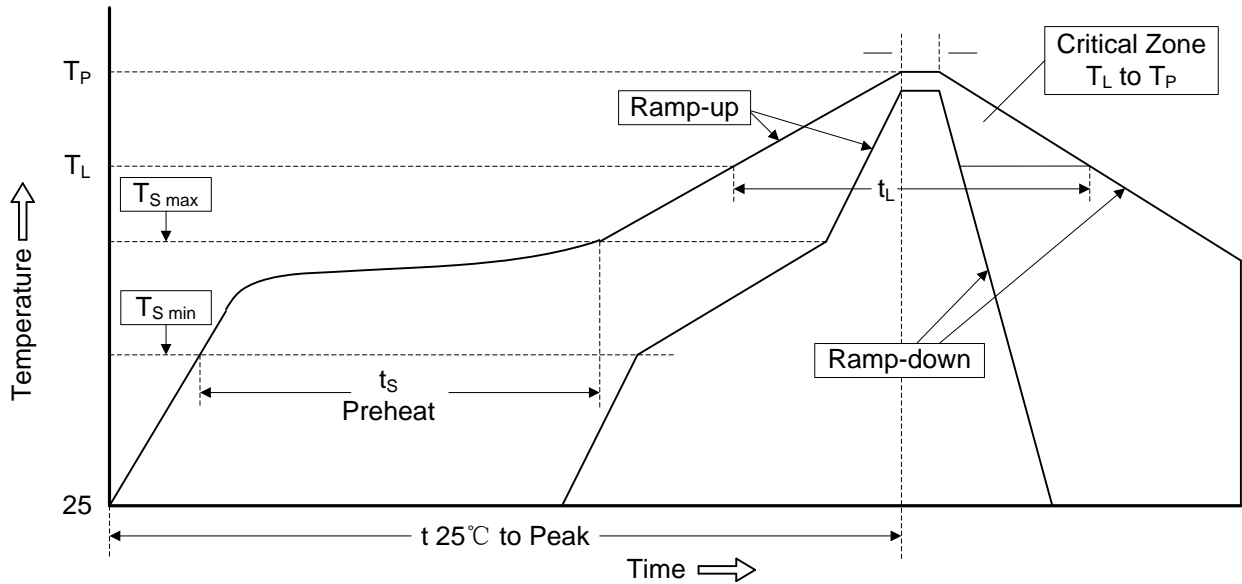

Figure 4. ESD Clamping (8kV Contact IEC61000-4-2)



Recommended Soldering Conditions

Reflow Soldering



Recommended Condition

Profile Feature	Pb Free Assembly
Average ramp-up rate (TL to TP)	3°C/second max.
Preheat -Temperature Min (TS min) -Temperature Max (TS max) -Time (min to max) (ts)	150°C 200°C 60-180 seconds
TS max to TL -Ramp-up Rate	3°C/second max.
Time maintained above: -Temperature (TL) -Time (tL)	217°C 60-150 seconds
Peak Temperature (TP)	260°C
Time within 5°C of actual Peak Temperature (tp)	20-40 seconds
Ramp-down Rate	6°C/second max.
Time 25°C to Peak Temperature	8 minutes max.

Outline Drawing – SOD323

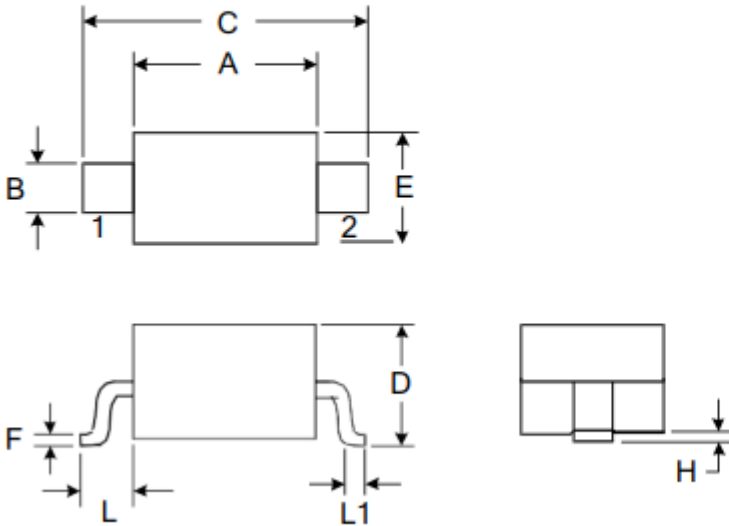

DIMENSIONS				
SYMBOL	MILLIMETER		INCHES	
	MIN	MAX	MIN	MAX
A	1.600	1.800	0.063	0.071
B	0.250	0.350	0.010	0.014
C	2.500	2.700	0.098	0.106
D		1.000		0.039
E	1.200	1.400	0.047	0.055
F	0.080	0.150	0.003	0.006
L	0.475 REF		0.019REF	
L1	0.250	0.400	0.010	0.016
H	0.000	0.100	0.000	0.004

Marking

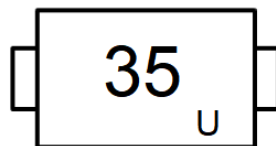

Ordering information

Order code	Package	Base qty	Delivery mode
UMW UBD32C05L01	SOD-323	3000	Tape and reel