

### Description

The OPA340 series rail-to-rail CMOS operational amplifiers are optimized for low-voltage, single-supply operation. Rail-to-rail input and output and high-speed operation make them ideal for driving sampling analog-to-digital (A/D) converters. They are also well-suited for general purpose and audio applications as well as providing I/V conversion at the output of digital-to-analog (D/A) converters. Single, dual, and quad versions have identical specifications for design flexibility.

The OPA340 series operate on a single supply as low as 2.5 V with an input common-mode voltage range that extends 500 mV below ground and 500 mV above the positive supply. Output voltage swing is to within 1 mV of the supply rails with a 100-kΩ load. These devices offer excellent dynamic response (BW = 5.5 MHz, SR = 6 V/μs), yet quiescent current is only 750 A. Dual and quad designs feature completely independent circuitry for lowest crosstalk and freedom from interaction.

All are specified from -40°C to 85°C and operate from -55°C to 125°C.

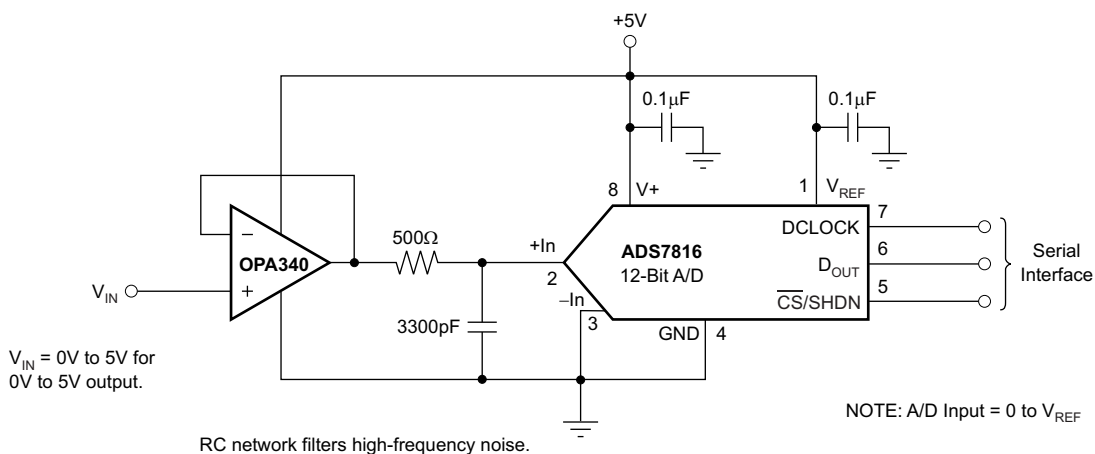
### Features

- Rail-to-Rail Input
- Rail-to-Rail Output (Within 1 mV)
- MicroSize Packages
- Wide Bandwidth: 5.5 MHz
- High Slew Rate: 6 V/μs
- Low THD + Noise: 0.0007% (f = 1 kHz)
- Low Quiescent Current: 750 μA/Channel
- Single, Dual, and Quad Versions

### Applications

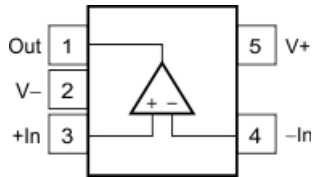
- Driving A/D Converters
- PCMCIA Cards
- Data Acquisition
- Process Control
- Audio Processing
- Communications
- Active Filters
- Test Equipment

OPA340 in Noninverting Configuration Driving ADS7816

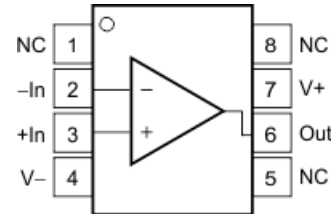


### Pin Configuration and Functions

OPA340: 5-Pin SOT-23  
Top View



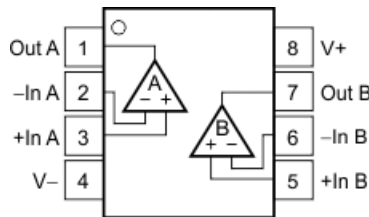
OPA340: 8-Pin SOP-8  
Top View



#### Pin Functions: OPA340

| NAME | PIN    |         | I/O | DESCRIPTION                                   |
|------|--------|---------|-----|---|
|      | SOT-23 | SOP     |     |   |
| -IN  | 4      | 2       | I   | Negative (inverting) input                    |
| +IN  | 3      | 3       | I   | Positive (noninverting) input                 |
| NC   | —      | 1, 5, 8 | —   | No internal connection (can be left floating) |
| OUT  | 1      | 6       | O   | Output  |
| V-   | 2      | 4       | —   | Negative (lowest) power supply                |
| V+   | 5      | 7       | —   | Positive (highest) power supply               |

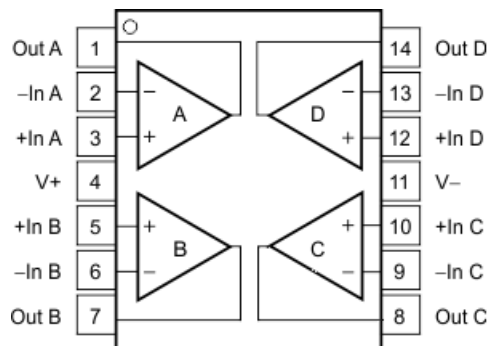
OPA2340: 8-Pin SOP-8  
Top View



#### Pin Functions: OPA2340

| NAME  | PIN |  | I/O | DESCRIPTION                             |
|-------|-----|--|-----|---|
|       | SOP |  |     |   |
| -IN A | 2   |  | I   | Negative (inverting) input channel A    |
| +IN A | 3   |  | I   | Positive (noninverting) input channel A |
| -IN B | 6   |  | I   | Negative (inverting) input channel B    |
| +IN B | 5   |  | I   | Positive (noninverting) input channel B |
| OUT A | 1   |  | O   | Output channel A                        |
| OUT B | 7   |  | O   | Output channel B                        |
| V-    | 4   |  | —   | Negative (lowest) power supply          |
| V+    | 8   |  | —   | Positive (highest) power supply         |

OPA4340: Package  
SOP-14  
Top View



Pin Functions: OPA4340

| NAME  | PIN SOP | I/O | DESCRIPTION                                   |
|-------|---------|-----|---|
| -IN A | 2       | I   | Negative (inverting) input channel A          |
| -IN B | 6       | I   | Negative (inverting) input channel B          |
| -IN C | 9       | I   | Negative (inverting) input channel C          |
| -IN D | 13      | I   | Negative (inverting) input channel D          |
| +IN A | 3       | I   | Positive (noninverting) input channel A       |
| +IN B | 5       | I   | Positive (noninverting) input channel B       |
| +IN C | 10      | I   | Positive (noninverting) input channel C       |
| +IN D | 12      | I   | Positive (noninverting) input channel D       |
| NC    | —       | —   | No internal connection (can be left floating) |
| OUT A | 1       | O   | Output, channel A                             |
| OUT B | 7       | O   | Output, channel B                             |
| OUT C | 8       | O   | Output, channel C                             |
| OUT D | 14      | O   | Output, channel D                             |
| V-    | 11      | —   | Negative (lowest) power supply                |
| V+    | 4       | —   | Positive (highest) power supply               |

### Absolute Maximum Ratings

over operating free-air temperature range (unless otherwise noted)<sup>(1)</sup>

|             |                                       | MIN        | MAX | UNIT |
|-------------|---------------------------------------|------------|-----|------|
| Voltage     | Supply voltage                        |            | 5.5 | V    |
|             | Signal input terminals <sup>(2)</sup> | -0.5       | 0.5 |      |
| Current     | Signal input terminals <sup>(2)</sup> |            | 10  | mA   |
|             | Output short circuit <sup>(3)</sup>   | Continuous |     |      |
| Temperature | Operating, T <sub>A</sub>             | -55        | 125 | °C   |
|             | Junction, T <sub>J</sub>              |            | 150 |      |
|             | Storage, T <sub>stg</sub>             | -55        | 125 |      |

- (1) Stresses beyond those listed under Absolute Maximum Ratings may cause permanent damage to the device. These are stress ratings only, which do not imply functional operation of the device at these or any other conditions beyond those indicated under Recommended Operating Conditions. Exposure to absolute-maximum-rated conditions for extended periods may affect device reliability.
- (2) Input terminals are diode-clamped to the power-supply rails. Input signals that can swing more than 0.5 V beyond the supply rails should be current limited to 10 mA or less.
- (3) Short-circuit to ground, one amplifier per package.

### ESD Ratings

|                    |                         | VALUE  | UNIT |
|--------------------|-------------------------|--|------|
| V <sub>(ESD)</sub> | Electrostatic discharge | Human-body model (HBM), per ANSI/ESDA/JEDEC JS-001 <sup>(1)</sup>              | ±600 |
|                    |                         | Charged-device model (CDM), per JEDEC specification JESD22-C101 <sup>(2)</sup> | ±250 |

### Recommended Operating Conditions

over operating free-air temperature range (unless otherwise noted)

|                       | MIN | MAX | UNIT |
|-----------------------|-----|-----|------|
| Supply voltage        | 2.7 | 5.5 | V    |
| Specified temperature | -40 | 125 | °C   |

### Thermal Information OPA340

| THERMAL METRIC <sup>(1)</sup>                                      | OPA340   |        |         | UNIT |
|--|----------|--------|---------|------|
|  | (SOT-23) | (SOP)  | (SOP)   |      |
|  | 5 PINS   | 8 PINS | 14 PINS |      |
| R <sub>θJA</sub> Junction-to-ambient thermal resistance            | 207.9    | 142    | 83.8    | °C/W |
| R <sub>θJC(top)</sub> Junction-to-case (top) thermal resistance    | 71.2     | 90.2   | 70.7    | °C/W |
| R <sub>θJB</sub> Junction-to-board thermal resistance              | 36.0     | 82.5   | 59.5    | °C/W |
| ψ <sub>JT</sub> Junction-to-top characterization parameter         | 2.0      | 39.4   | 11.6    | °C/W |
| ψ <sub>JB</sub> Junction-to-board characterization parameter       | 35.2     | 82     | 37.7    | °C/W |
| R <sub>θJC(bot)</sub> Junction-to-case (bottom) thermal resistance | —        | —      | —       | °C/W |

### Thermal Information – OPA2340

| THERMAL METRIC <sup>(1)</sup> |  | OPA2340 |      |
|-------------------------------|--|---------|------|
|                               |  | (SOP)   |      |
|                               |  | 8 PINS  |      |
|                               |  |         | UNIT |
| R <sub>θJA</sub>              | Junction-to-ambient thermal resistance       | 138.4   | °C/W |
| R <sub>θJC(top)</sub>         | Junction-to-case (top) thermal resistance    | 89.5    | °C/W |
| R <sub>θJB</sub>              | Junction-to-board thermal resistance         | 78.6    | °C/W |
| ψ <sub>JT</sub>               | Junction-to-top characterization parameter   | 29.9    | °C/W |
| ψ <sub>JB</sub>               | Junction-to-board characterization parameter | 78.1    | °C/W |
| R <sub>θJC(bot)</sub>         | Junction-to-case (bottom) thermal resistance | —       | °C/W |

### Electrical Characteristics

At T<sub>A</sub> = 25°C, R<sub>L</sub> = 10 kΩ connected to V<sub>S</sub>/2, and V<sub>OUT</sub> = V<sub>S</sub>/2, unless otherwise noted.

| PARAMETER              |                                      | TEST CONDITIONS   | MIN  | TYP <sup>(1)</sup> | MAX        | UNIT              |
|------------------------|--------------------------------------|---|------|--------------------|------------|-------------------|
| V <sub>OS</sub>        | Input offset voltage                 | V <sub>S</sub> = 5 V  |      | ±150               | ±500       | μV                |
| dV <sub>OS</sub> /dt   | Input offset voltage vs temperature  | T <sub>A</sub> = -40°C to 85°C, V <sub>S</sub> = 5 V  |      | ±2.5               |            | μV/°C             |
| PSRR                   | Input offset voltage vs power supply | V <sub>S</sub> = 2.7 V to 5.5 V, V <sub>CM</sub> = 0 V  |      | 30                 | 120        | μV/V              |
|                        |                                      | Over temperature<br>V <sub>S</sub> = 2.7 V to 5.5 V, V <sub>CM</sub> = 0 V,<br>T <sub>A</sub> = -40°C to 85°C, V <sub>S</sub> = 5 V |      |                    | 120        | μV/°C             |
| Channel separation, DC |                                      |   |      | 0.2                |            | μV/V              |
| I <sub>S</sub>         | Input bias current                   |   |      | ±0.2               | ±10        | pA                |
|                        |                                      | Over temperature<br>T <sub>A</sub> = -40°C to 85°C, V <sub>S</sub> = 5 V  |      |                    | ±60        |                   |
| I <sub>OS</sub>        | Input offset current                 |   |      | ±0.2               | ±10        | pA                |
| Input voltage noise    |                                      | f = 0.1 kHz to 50 kHz   |      | 8                  |            | μV <sub>RMS</sub> |
| e <sub>n</sub>         | Input voltage noise density          | f = 1 kHz   |      | 25                 |            | nV/√Hz            |
| i <sub>n</sub>         | Current noise density                | f = 1 kHz   |      | 3                  |            | fA/√Hz            |
| V <sub>CM</sub>        | Common-mode voltage range            |   | -0.3 |                    | (V+) + 0.3 | V                 |
| CMRR                   | Common-mode rejection ratio          | -0.3 V < V <sub>CM</sub> < (V+) - 1.8 V   | 80   | 92                 |            | dB                |
|                        |                                      | V <sub>S</sub> = 5 V, -0.3 V < V <sub>CM</sub> < 5.3 V  | 70   | 84                 |            |                   |
|                        |                                      | V <sub>S</sub> = 2.7 V, -0.3 V < V <sub>CM</sub> < 3 V  | 66   | 80                 |            |                   |

(1) V<sub>S</sub> = 5 V.

**Electrical Characteristics (continued)**

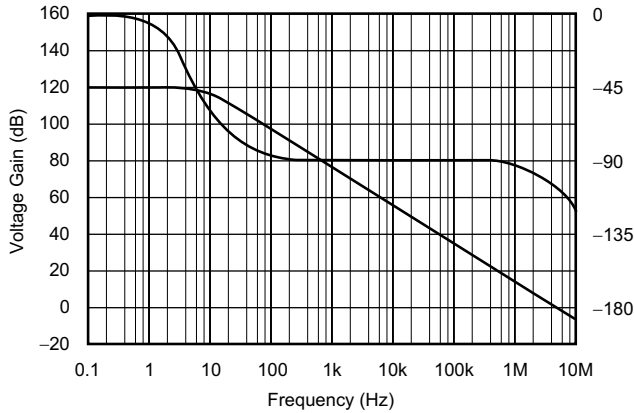
At  $T_A = 25^\circ\text{C}$ ,  $R_L = 10\text{ k}\Omega$  connected to  $V_S/2$ , and  $V_{OUT} = V_S/2$ , unless otherwise noted.

| PARAMETER         |   | TEST CONDITIONS  | MIN  | TYP <sup>(1)</sup>    | MAX | UNIT                         |     |
|-------------------|---|--|--|-----------------------|-----|------------------------------|-----|
| Differential      |   |  |  | $10^{13} \parallel 3$ |     | $\Omega \parallel \text{pF}$ |     |
| Common-mode       |   |  |  | $10^{13} \parallel 6$ |     | $\Omega \parallel \text{pF}$ |     |
| A <sub>OL</sub>   | Open-loop voltage gain                        | R <sub>L</sub> = 100 kΩ,<br>5 mV < V <sub>O</sub> < (V+) – 5 mV                              | 106  | 124                   |     | dB                           |     |
|                   |   | R <sub>L</sub> = 10 kΩ,<br>5 mV < V <sub>O</sub> < (V+) – 50 mV                              | 100  | 120                   |     |                              |     |
|                   |   | R <sub>L</sub> = 2 kΩ,<br>200 mV < V <sub>O</sub> < (V+) – 200 mV                            | 94   | 114                   |     |                              |     |
|                   |   | Over temperature   | R <sub>L</sub> = 100 kΩ,<br>5 mV < V <sub>O</sub> < (V+) – 5 mV,<br>T <sub>A</sub> = –40°C to 85°C, V <sub>S</sub> = 5 V   | 106                   |     |                              |     |
|                   |   |  | R <sub>L</sub> = 10 kΩ,<br>5 mV < V <sub>O</sub> < (V+) – 50 mV,<br>T <sub>A</sub> = –40°C to 85°C, V <sub>S</sub> = 5 V   | 100                   |     |                              |     |
|                   |   |  | R <sub>L</sub> = 2 kΩ,<br>200 mV < V <sub>O</sub> < (V+) – 200 mV,<br>T <sub>A</sub> = –40°C to 85°C, V <sub>S</sub> = 5 V | 94                    |     |                              |     |
| GBW               | Gain-bandwidth product                        | G = 1  |  | 5.5                   |     | MHz                          |     |
| SR                | Slew rate                                     | V <sub>S</sub> = 5 V, G = 1, C <sub>L</sub> = 100 pF   |  | 6                     |     | V/μs                         |     |
|                   | Settling time, 0.1%                           | V <sub>S</sub> = 5 V, 2-V step, C <sub>L</sub> = 100 pF                                      |  | 1                     |     | μs                           |     |
|                   | Settling time, 0.01%                          | V <sub>S</sub> = 5 V, 2-V step, C <sub>L</sub> = 100 pF                                      |  | 1.6                   |     | μs                           |     |
|                   | Overload recovery time                        | V <sub>IN</sub> × G = V <sub>S</sub>   |  | 0.2                   |     | μs                           |     |
| THD+N             | Total harmonic distortion + noise             | V <sub>S</sub> = 5 V, V <sub>O</sub> = 3V <sub>PP</sub> <sup>(2)</sup> , G = 1,<br>f = 1 kHz |  | 0.0007%               |     |                              |     |
|                   | Voltage output swing from rail <sup>(2)</sup> | R <sub>L</sub> = 100 kΩ, A <sub>OL</sub> ≥ 106 dB  |  | 1                     | 5   | mV                           |     |
|                   |   | R <sub>L</sub> = 10 kΩ, A <sub>OL</sub> ≥ 106 dB   |  | 10                    |     |                              |     |
|                   |   | R <sub>L</sub> = 2 kΩ, A <sub>OL</sub> ≥ 106 dB  |  | 40                    |     |                              |     |
|                   |   | Over temperature   | R <sub>L</sub> = 100 kΩ, A <sub>OL</sub> ≥ 106 dB,<br>T <sub>A</sub> = –40°C to 85°C, V <sub>S</sub> = 5 V                 |                       |     |                              | 5   |
|                   |   |  | R <sub>L</sub> = 10 kΩ, A <sub>OL</sub> ≥ 106 dB,<br>T <sub>A</sub> = –40°C to 85°C, V <sub>S</sub> = 5 V                  |                       |     |                              | 50  |
|                   |   |  | R <sub>L</sub> = 2 kΩ, A <sub>OL</sub> ≥ 106 dB,<br>T <sub>A</sub> = –40°C to 85°C, V <sub>S</sub> = 5 V                   |                       |     |                              | 200 |
| I <sub>SC</sub>   | Short-circuit current                         |  |  | ±50                   |     | mA                           |     |
| C <sub>LOAD</sub> | Capacitive load drive                         |  | See Typical Characteristics  |                       |     |                              |     |
| V <sub>S</sub>    | Specified voltage range                       |  | 2.7  |                       | 5   | V                            |     |
|                   | Operating voltage range                       | Lower end  |  | 2.5                   |     | V                            |     |
|                   |   | Higher end   |  | 5.5                   |     |                              |     |
| I <sub>Q</sub>    | Quiescent current (per amplifier)             | I <sub>O</sub> = 0, V <sub>S</sub> = 5 V   |  | 750                   | 950 | μA                           |     |
|                   |   | Over temperature   | I <sub>O</sub> = 0, V <sub>S</sub> = 5 V, T <sub>A</sub> = –40°C to 85°C   |                       |     |                              | 100 |
|                   | Specified range                               |  | –40  |                       | 85  | °C                           |     |
|                   | Operating range                               |  | –55  |                       | 125 | °C                           |     |
|                   | Storage range                                 |  | –55  |                       | 125 | °C                           |     |

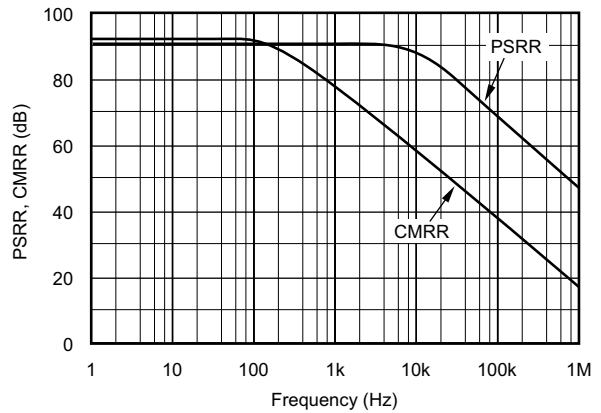
(2) Output voltage swings are measured between the output and power-supply rails.

**Typical Characteristics**

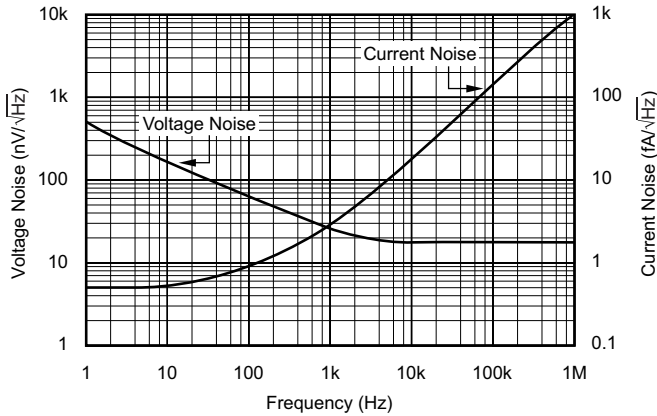
At  $T_A = 25^\circ\text{C}$ ,  $V_S = 5\text{ V}$ , and  $R_L = 10\text{ k}\Omega$  connected to  $V_S/2$ , unless otherwise noted.



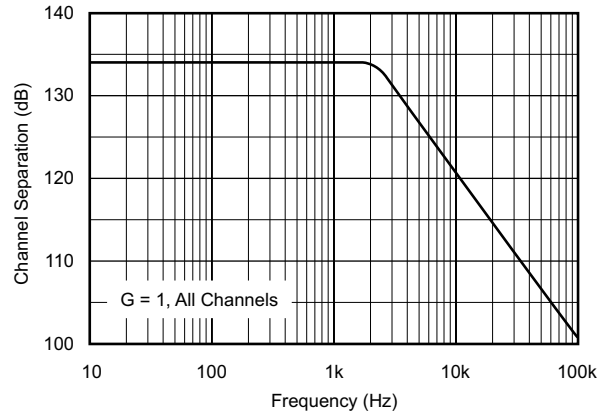
**Figure 1. Open-Loop Gain/Phase vs Frequency**



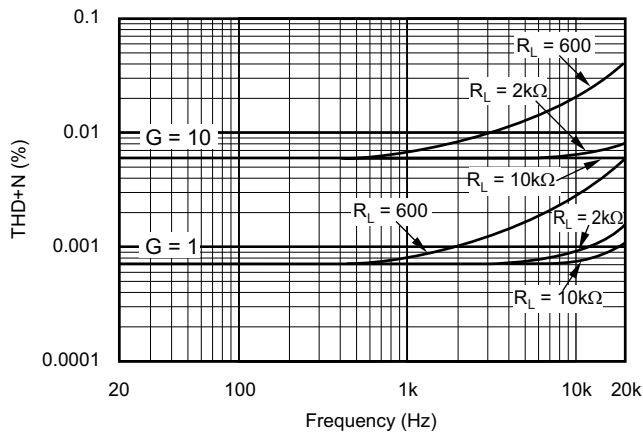
**Figure 2. Power-Supply and Common-Mode Rejection vs Frequency**



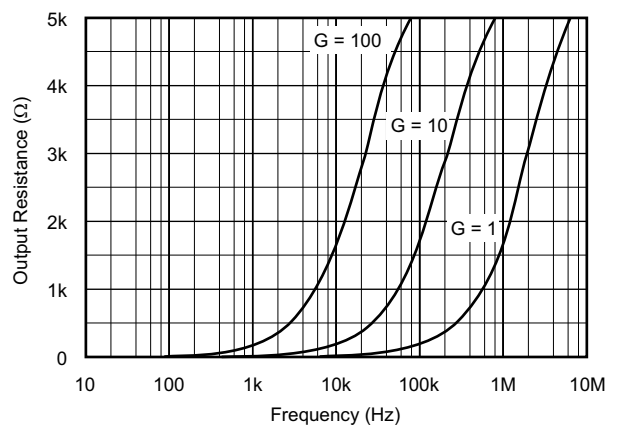
**Figure 3. Input Voltage and Current Noise Spectral Density vs Frequency**



**Figure 4. Channel Separation vs Frequency**



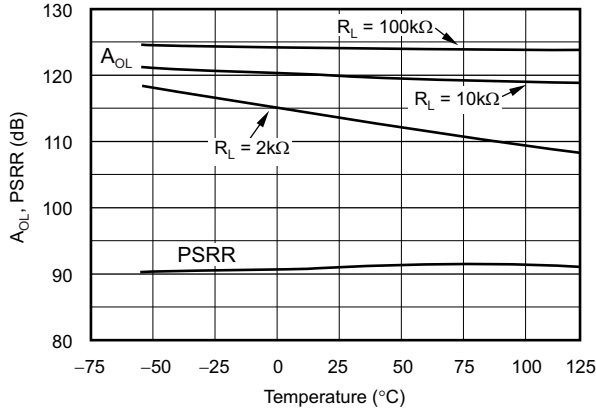
**Figure 5. Total Harmonic Distortion + Noise vs Frequency**



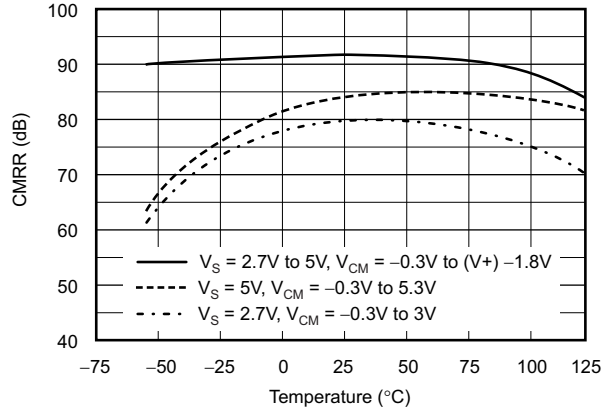
**Figure 6. Closed-Loop Output Impedance vs Frequency**

**Typical Characteristics**

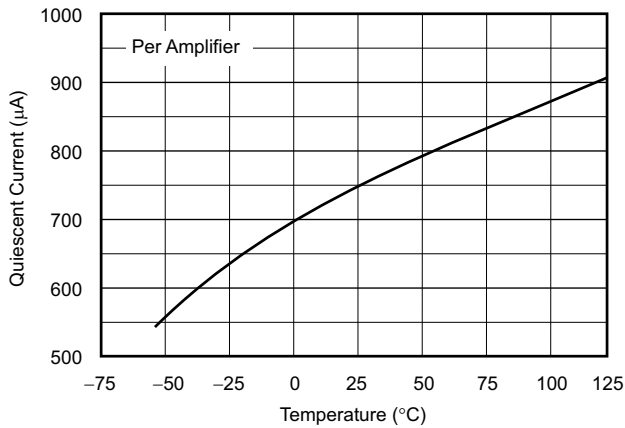
At  $T_A = 25^\circ\text{C}$ ,  $V_S = 5\text{ V}$ , and  $R_L = 10\text{ k}\Omega$  connected to  $V_S/2$ , unless otherwise noted.



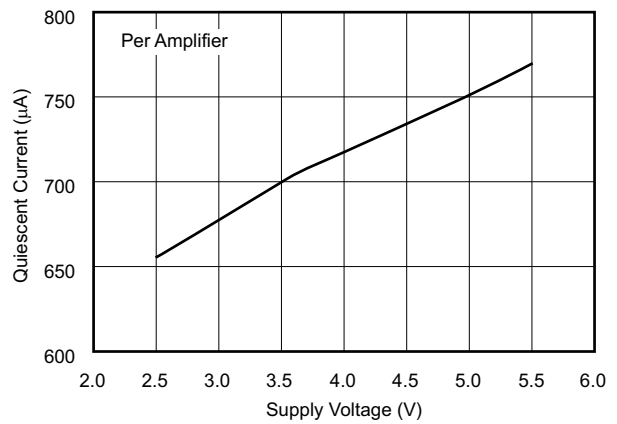
**Figure 7. Open-Loop Gain and Power-Supply Rejection vs Temperature**



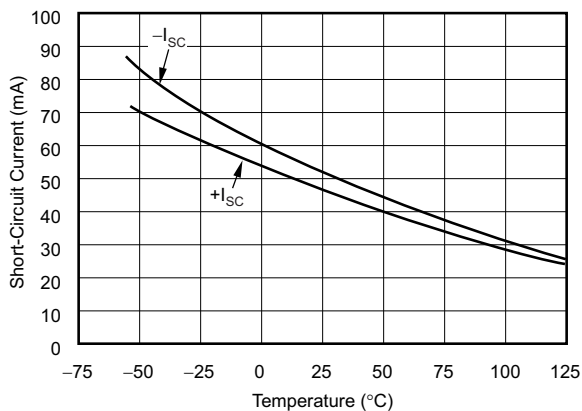
**Figure 8. Common-Mode Rejection vs Temperature**



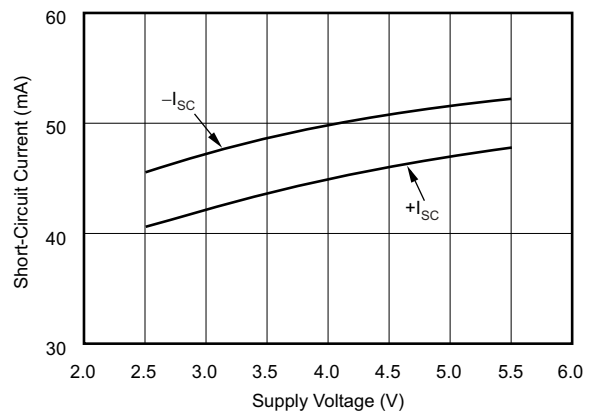
**Figure 9. Quiescent Current vs Temperature**



**Figure 10. Quiescent Current vs Supply Voltage**



**Figure 11. Short-Circuit Current vs Temperature**

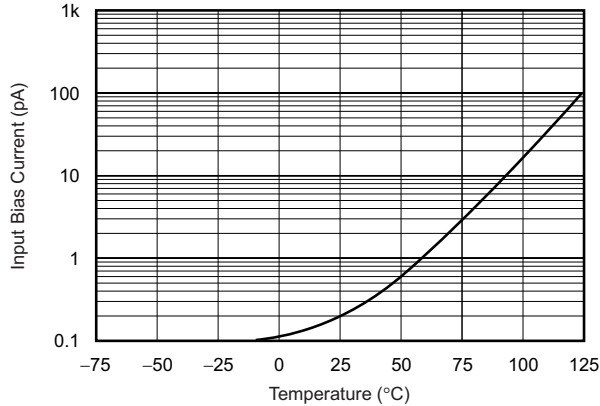


**Figure 12. Short-Circuit Current vs Supply Voltage**

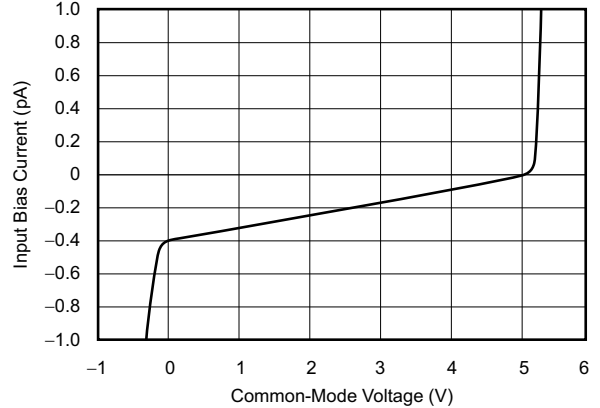


**Typical Characteristics**

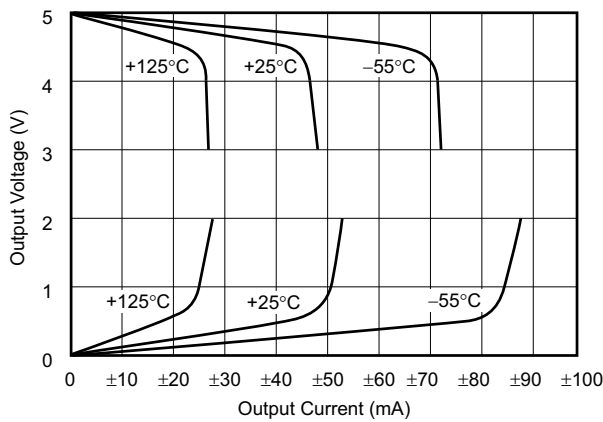
At  $T_A = 25^\circ\text{C}$ ,  $V_S = 5\text{ V}$ , and  $R_L = 10\text{ k}\Omega$  connected to  $V_S/2$ , unless otherwise noted.



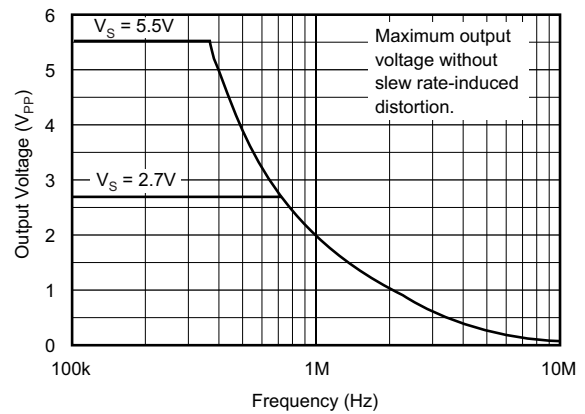
**Figure 13. Input Bias Current vs Temperature**



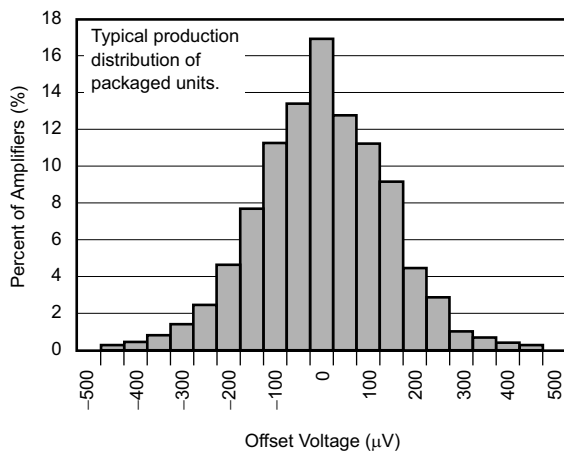
**Figure 14. Input Bias Current vs Input Common-Mode Voltage**



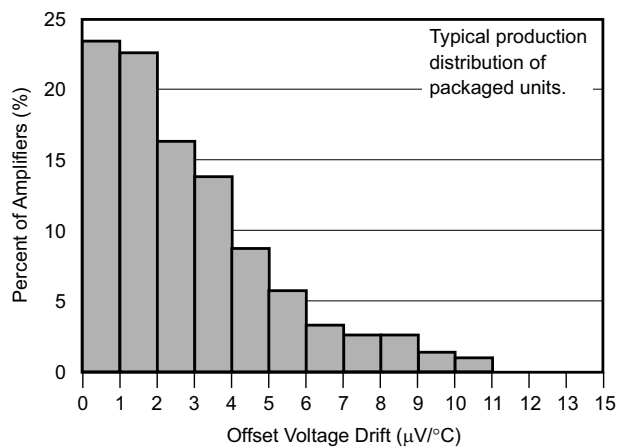
**Figure 15. Output Voltage Swing vs Output Current**



**Figure 16. Maximum Output Voltage vs Frequency**



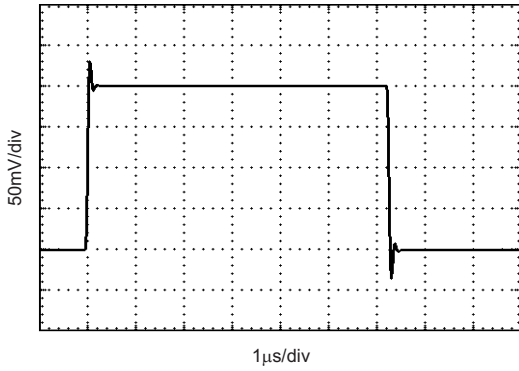
**Figure 17. Offset Voltage Production Distribution**



**Figure 18. Offset Voltage Drift Magnitude Production Distribution**

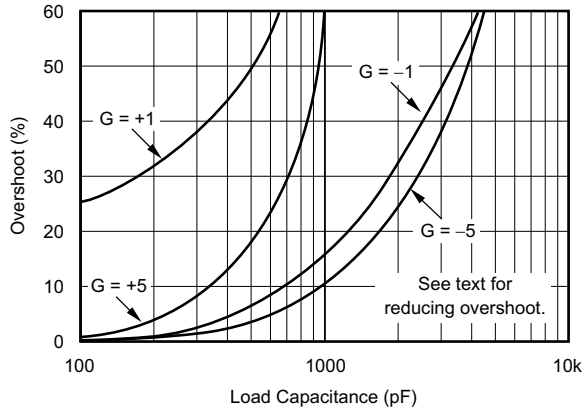
**Typical Characteristics**

At  $T_A = 25^\circ\text{C}$ ,  $V_S = 5\text{ V}$ , and  $R_L = 10\text{ k}\Omega$  connected to  $V_S/2$ , unless otherwise noted.

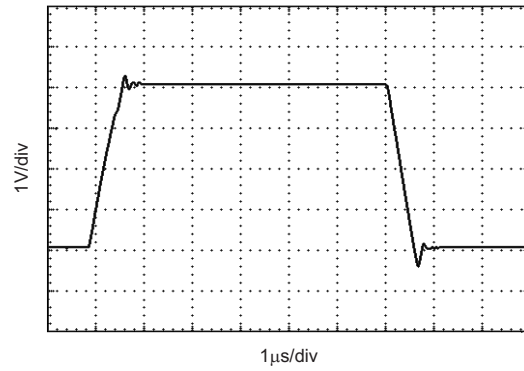


$C_L = 100\text{ pF}$

**Figure 19. Small-Signal Step Response**

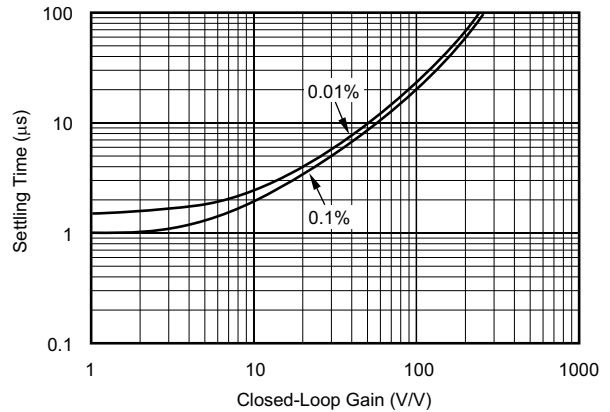


**Figure 21. Small-Signal Overshoot vs Load Capacitance**



$C_L = 100\text{ pF}$

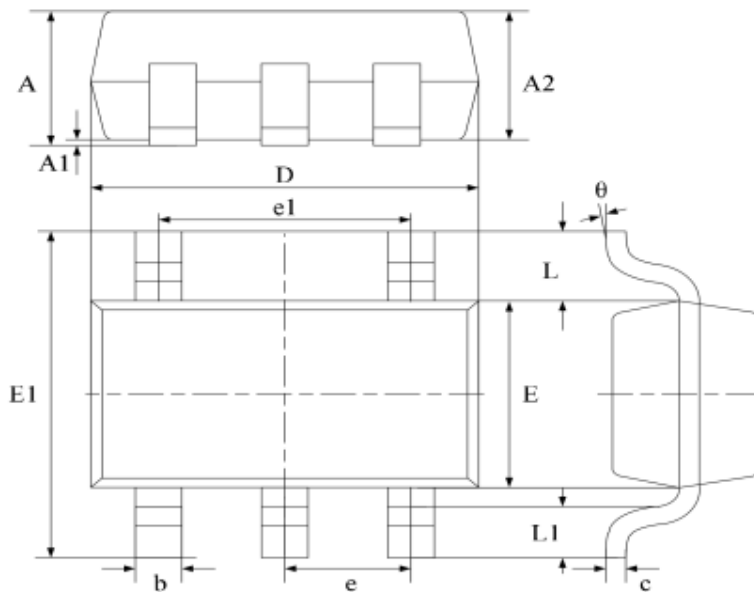
**Figure 20. Large-Signal Step Response**



**Figure 22. Settling Time vs Closed-Loop Gain**

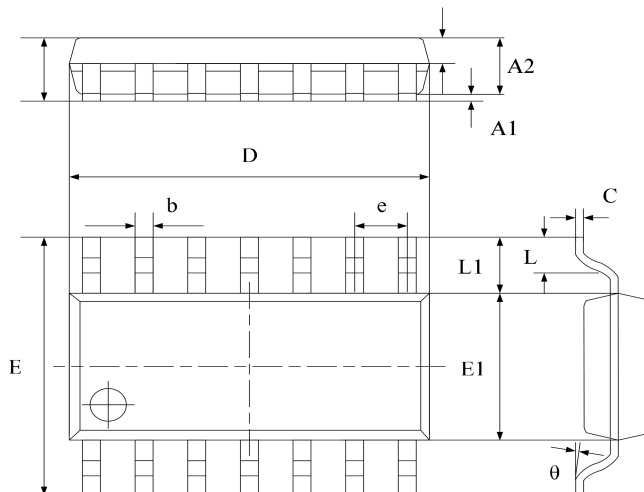
Package Dimension

SOT23-5



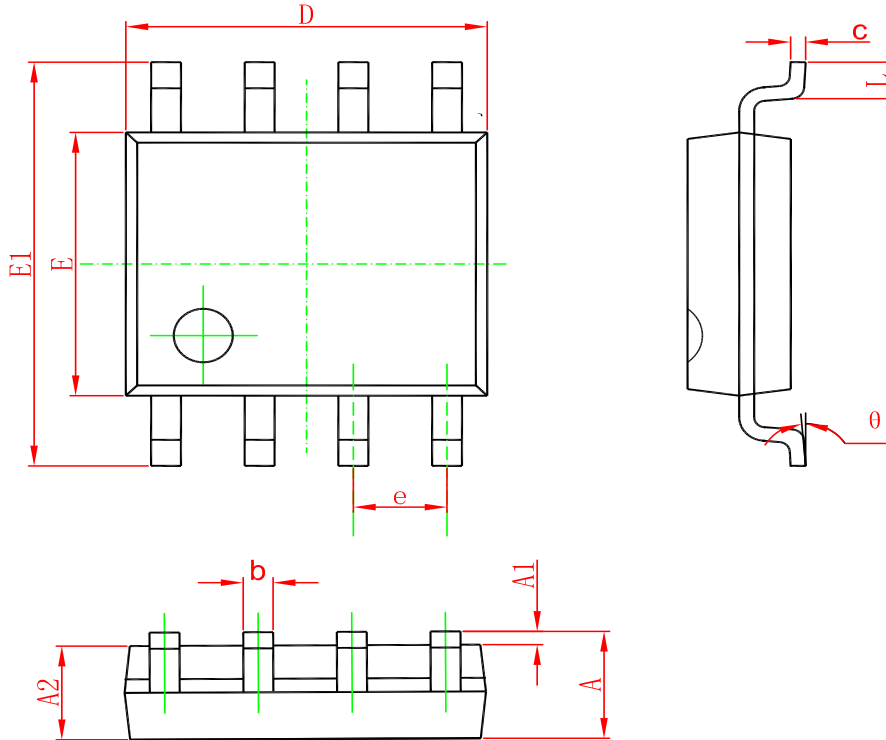
| Symbol | Dimensions<br>In Millimeters |       | Dimensions<br>In Inches |       |
|--------|------------------------------|-------|-------------------------|-------|
|        | Min                          | Max   | Min                     | Max   |
| A      | 1.040                        | 1.350 | 0.042                   | 0.055 |
| A1     | 0.040                        | 0.150 | 0.002                   | 0.006 |
| A2     | 1.000                        | 1.200 | 0.041                   | 0.049 |
| b      | 0.380                        | 0.480 | 0.015                   | 0.020 |
| c      | 0.110                        | 0.210 | 0.004                   | 0.009 |
| D      | 2.720                        | 3.120 | 0.111                   | 0.127 |
| E      | 1.400                        | 1.800 | 0.057                   | 0.073 |
| E1     | 2.600                        | 3.000 | 0.106                   | 0.122 |
| e      | 0.950 typ.                   |       | 0.037 typ.              |       |
| e1     | 1.900 typ.                   |       | 0.078 typ.              |       |
| L      | 0.700 ref.                   |       | 0.028 ref.              |       |
| L1     | 0.300                        | 0.600 | 0.012                   | 0.024 |
| θ      | 0°                           | 8°    | 0°                      | 8°    |

SOP-14



| Symbol | Dimensions<br>In Millimeters |       | Dimensions<br>In Inches |       |
|--------|------------------------------|-------|-------------------------|-------|
|        | Min                          | Max   | Min                     | Max   |
| A      | 1.450                        | 1.850 | 0.059                   | 0.076 |
| A1     | 0.100                        | 0.300 | 0.004                   | 0.012 |
| A2     | 1.350                        | 1.550 | 0.055                   | 0.063 |
| A3     | 0.550                        | 0.750 | 0.022                   | 0.031 |
| b      | 0.406typ.                    |       | 0.017typ.               |       |
| C      | 0.203typ.                    |       | 0.008typ.               |       |
| D      | 8.630                        | 8.830 | 0.352                   | 0.360 |
| E      | 5.840                        | 6.240 | 0.238                   | 0.255 |
| E1     | 3.850                        | 4.050 | 0.157                   | 0.165 |
| e      | 1.270 typ.                   |       | 0.050 typ.              |       |
| L1     | 1.040 ref.                   |       | 0.041 ref.              |       |
| L      | 0.350                        | 0.750 | 0.014                   | 0.031 |
| θ      | 2°                           | 8°    | 2°                      | 8°    |

SOP-8



| Symbol | Dimensions In Millimeters |       | Dimensions In Inches |       |
|--------|---------------------------|-------|----------------------|-------|
|        | Min                       | Max   | Min                  | Max   |
| A      | 1.350                     | 1.750 | 0.053                | 0.069 |
| A1     | 0.100                     | 0.250 | 0.004                | 0.010 |
| A2     | 1.350                     | 1.550 | 0.053                | 0.061 |
| b      | 0.330                     | 0.510 | 0.013                | 0.020 |
| c      | 0.170                     | 0.250 | 0.006                | 0.010 |
| D      | 4.700                     | 5.100 | 0.185                | 0.200 |
| E      | 3.800                     | 4.000 | 0.150                | 0.157 |
| E1     | 5.800                     | 6.200 | 0.228                | 0.244 |
| e      | 1.270(BSC)                |       | 0.050(BSC)           |       |
| L      | 0.400                     | 1.270 | 0.016                | 0.050 |
| θ      | 0°                        | 8°    | 0°                   | 8°    |

### Ordering information

| Order code    | Package | Baseqty | Deliverymode  | Marking   |
|---------------|---------|---------|---------------|-----------|
| UMW OPA4340UA | SOP-14  | 2500    | Tape and reel | OPA4340UA |
| UMW OPA2340UA | SOP-8   | 2500    | Tape and reel | OPA2340   |
| UMW OPA340UA  | SOP-8   | 2500    | Tape and reel | OPA340UA  |
| UMW OPA340NA  | SOT23-5 | 3000    | Tape and reel | A40 U     |