

General Description

The SN74LVC2G34 is a high performance dual buffer operating from a 1.65 to 5.5 V supply. This device is fabricated with advanced CMOS technology to achieve ultra-high speed with high output drive.

Features

- Designed for 1.65V to 5.5V V_{CC} Operation
- Overvoltage Tolerant Inputs
- 24 mA Balanced Output Sink and Source Capability
- Near Zero Static Supply Current Substantially Reduces System Power Requirements
- These Devices are Pb-Free and are RoHS Compliant

Pin Configuration

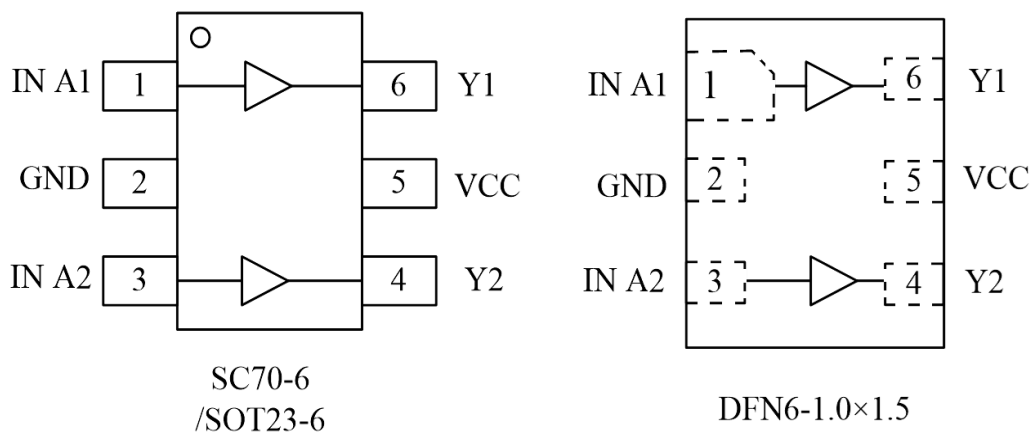

Figure1. Pinouts (Top View)

Pin Function

PIN	ASSIGNMENT
1	IN A1
2	GND
3	IN A2
4	Y2
5	VCC
6	Y1

Block Diagram

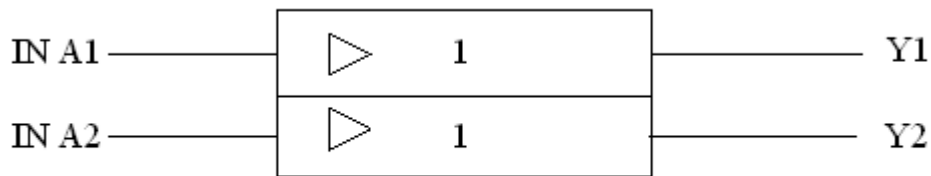

Figure2.Logic symbol

Functional Description

Function Table

A Input	Y Output
L	L
H	H

Absolute Maximum Ratings

Symbol	Parameter	Value	Unit
V_{CC}	DC Supply Voltage	-0.5 to 7.0	V
V_I	DC Input Voltage	$-0.5 \leq V_I \leq +7.0$	V
V_O	DC Output Voltage Output in Higher or Low State (Note 1)	-0.5 to $V_{CC} + 0.5$	V
I_{IK}	DC Input Diode Current $V_I < GND$	-50	mA
I_{OK}	DC Output Diode Current $V_O < GND, V_O > V_{CC}$	± 50	mA
I_O	DC Output Sink Current	± 50	mA
I_{CC}	DC Supply Current per Supply Pin	± 100	mA
I_{GND}	DC Ground Current per Supply Pin	± 100	mA
T_{STG}	Storage Temperature Range	-65 to 150	°C
T_L	Lead Temperature, 1 mm from Case for 10 Seconds	260	°C
T_J	Junction Temperature Under Bias	150	°C
θ_{JA}	Thermal Resistance SC70-6	333	°C/W
	SOT23-6	225	
	DFN6	423	
P_D	Power Dissipation in Still Air at 85 °C	200	mW
MSL	Moisture Sensitivity	Level 1	
ESD	ESD Classification Human Body Model (Note 2)	2000	V
	Machine Model (Note3)	200	
	Charged Device Model (Note 4)	N/A	
$I_{Latchup}$	Latchup Performance Above V_{CC} and Below GND at 125 °C (Note 5)	± 100	mA

Stresses exceeding those listed in the Maximum Ratings table may damage the device. If any of these limits are exceeded, device functionality should not be assumed, damage may occur and reliability may be affected.

1. IO absolute maximum rating must be observed.
2. Tested to EIA/JESD22-A114-A, rated to EIA/JESD22-A114-B.
3. Tested to EIA/JESD22-A115-A, rated to EIA/JESD22-A115-A.
4. Tested to JESD22-C101-A.
5. Tested to EIA/JESD78.

Recommended Operating Conditions

Symbol	Parameter	Min	Max	Unit
V_{CC}	DC Supply Voltage Operating	1.65	5.5	V
	Date Retention	1.5	5.5	
V_{IN}	DC Input Voltage	0	5.5	V
V_{OUT}	DC Output Voltage (High or Low State)	0	5.5	V
T_A	Operating Temperature Range	-40	85	°C
t_r, t_f	Input Rise and Fall Time $V_{CC} = 2.5 V \pm 0.2 V$	0	20	ns/V
	$V_{CC} = 3.0 V \pm 0.3 V$	0	10	
	$V_{CC} = 5.0 V \pm 0.5 V$	0	5	

Functional operation above the stresses listed in the Recommended Operating Ranges is not implied.

Electrical Characteristics
DC ELECTRICAL CHARACTERISTICS

Symbol	Parameter	Condition	VCC(V)	TA = 25 °C			-40°C ≤ TA ≤ 85°C		Unit
				Min	Typ	Max	Min	Max	
V _{IH}	High-Level Input Voltage		1.65to1.95 2.3 to 5.5	0.75V _{cc} 0.7V _{cc}			0.75V _{cc} 0.7V _{cc}		V
V _{IL}	Low-Level Input Voltage		1.65to1.95 2.3 to 5.5			0.25V _{cc} 0.3V _{cc}		0.25V _{cc} 0.3V _{cc}	V
V _{OH}	High-Level Output Voltage V _{IN} = V _{IL}	I _{OH} = -100uA	1.65to5.5	V _{cc} -0.1	V _{cc}		V _{cc} -0.1		V
		I _{OH} = -3mA	1.65	1.29	1.52		1.29		
		I _{OH} = -8mA	2.3	1.9	2.1		1.9		
		I _{OH} = -12mA	2.7	2.2	2.4		2.2		
		I _{OH} = -16mA	3.0	2.4	2.7		2.4		
		I _{OH} = -24mA	3.0	2.3	2.5		2.3		
		I _{OH} = -32mA	4.5	3.8	4.0		3.8		
V _{OL}	Low-Level Output Voltage V _{IN} = V _{IH}	I _{OH} = 100uA	1.65to5.5		0.0	0.1		0.1	V
		I _{OL} = 3mA	1.65		0.08	0.24		0.24	
		I _{OL} = 8mA	2.3		0.20	0.3		0.3	
		I _{OL} = 12mA	2.7		0.22	0.4		0.4	
		I _{OL} = 16mA	3.0		0.28	0.4		0.4	
		I _{OL} = 24mA	3.0		0.38	0.55		0.55	
		I _{OL} = 32mA	4.5		0.42	0.55		0.55	
I _{IN}	Input Leakage Current	V _{IN} = 5.5V or GND	0 to 5.5		±0.1			±1.0	uA
I _{OFF}	Power Off Leakage Current	V _{IN} = 5.5V or V _{OUT} = 5.5V	0			1		10	uA
I _{CC}	Quiescent Supply Current	V _{IN} = 5.5V or GND	5.5					10	uA

Product parametric performance is indicated in the Electrical Characteristics for the listed test conditions, unless otherwise noted. Product performance may not be indicated by the Electrical Characteristics if operated under different conditions.

AC ELECTRICAL CHARACTERISTICS

tr=tf= 2.5ns

Symbol	Parameter	Condition	V _{CC} (V)	TA = 25 °C			-40°C ≤TA≤85°C		Unit
				Min	Typ	Max	Min	Max	
t _{PLH} t _{PHL}	Propagation Delay (Figure3and4)	R _L = 1MΩ C _L = 15 pF	1.65	2.0	10.1	12.9	2.0	13.9	ns
			1.8	2.0	9.1	11.6	2.0	12.4	
		R _L = 1MΩ C _L = 15 pF	2.5	0.2	6.0	7.7	0.8	8.2	
		R _L = 1MΩ C _L = 15 pF	3.3	0.8	5.0	6.5	0.5	7.0	
		R _L = 500Ω C _L =50 pF		1.2	5.6	7.1	1.5	7.6	
		R _L = 1MΩ C _L = 15 pF	5.0	0.5	4.4	5.6	0.5	6.1	
R _L = 500Ω C _L =50 pF	0.8	4.8		6.1	0.8	6.6			

CAPACITIVE CHARACTERISTICS

Symbol	Parameter	Condition	Typical	Unit
C _{IN}	Input Capacitance	V _{CC} = 5.5 V, V _I = 0 V or V _{CC}	>2.5	pF
C _{PD}	Power Dissipation Capacitance (Note 6)	10MHz, V _{CC} = 3.3 V, V _I = 0 V or V _{CC}	4	pF
		10MHz, V _{CC} = 5.5 V, V _I = 0 V or V _{CC}	4	

6. C_{PD} is defined as the value of the internal equivalent capacitance which is calculated from the operating current consumption without load. Average operating current can be obtained by the equation:

$I_{CC(OPR)} = C_{PD} * V_{CC} * f_{in} + I_{CC} * C_{PD}$ is used to determine the no-load dynamic power consumption;

$P_D = C_{PD} * V_{CC}^2 * f_{in} + I_{CC} * V_{CC} * Fig.$

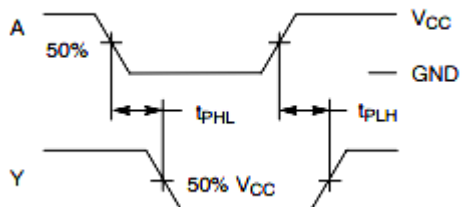

PROPAGATION DELAYS
t_R = t_F = 2.5 ns, 10% to 90%;
f = 1 MHz; t_W = 500 ns

Figure 3. Switching Waveforms

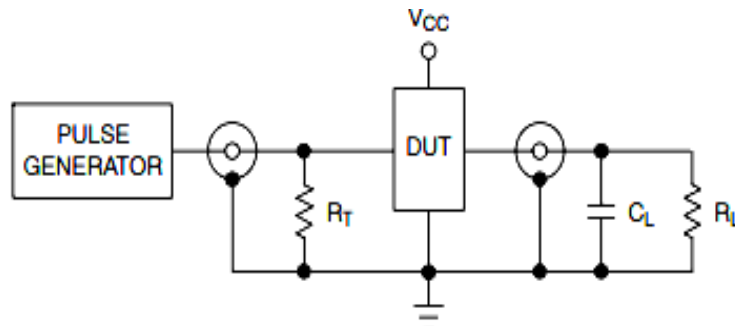

RT=50Ω(typ)

Figure4. Test Circuit

Package Dimension

SC70-6

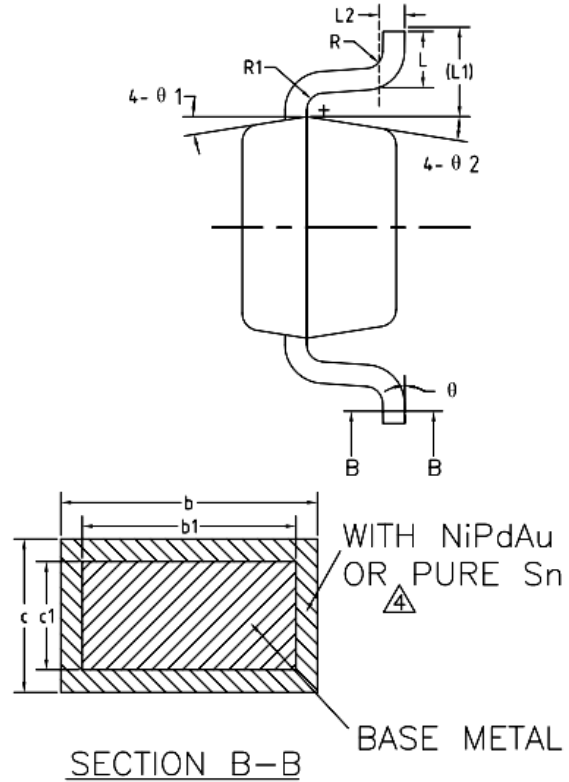
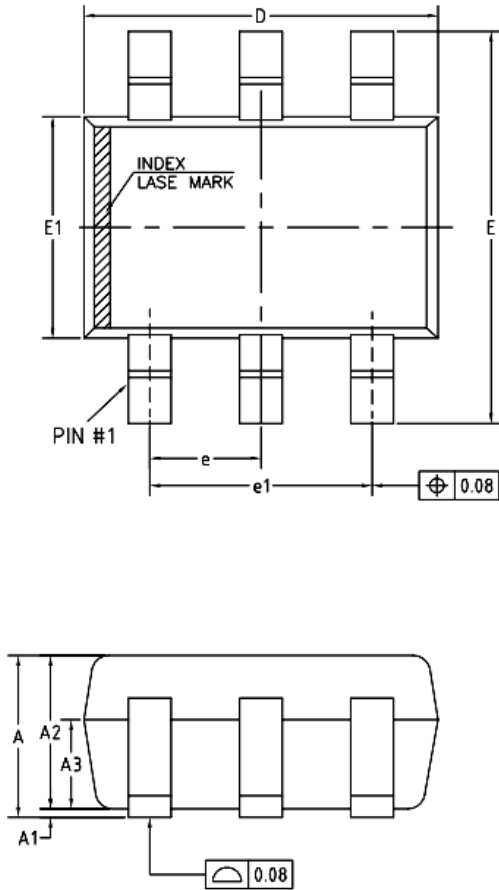

COMMON DIMENSIONS
(UNITS OF MEASURE=MILLIMETER)

SYMBOL	MIN	NOM	MAX
A	0.85	—	1.05
A1	0	—	0.10
A2	0.80	0.90	1.00
A3	0.47	0.52	0.57
b	NiPdAu 0.22	—	0.29
	PURE Sn 0.23	—	0.33
b1	0.22	0.25	0.28
c	NiPdAu 0.115	—	0.15
	PURE Sn 0.12	—	0.18
c1	0.115	0.13	0.14
D	2.02	2.07	2.12
E	2.20	2.30	2.40
E1	1.25	1.30	1.35
e	0.60	0.65	0.70
e1	1.20	1.30	1.40
L	0.28	0.33	0.38
L1	0.50REF		
L2	0.15BSC		
R	0.10	—	—
R1	0.10	—	0.25
θ	0°	—	8°
θ 1	6°	9°	12°
θ 2	6°	9°	12°

SOT23-6

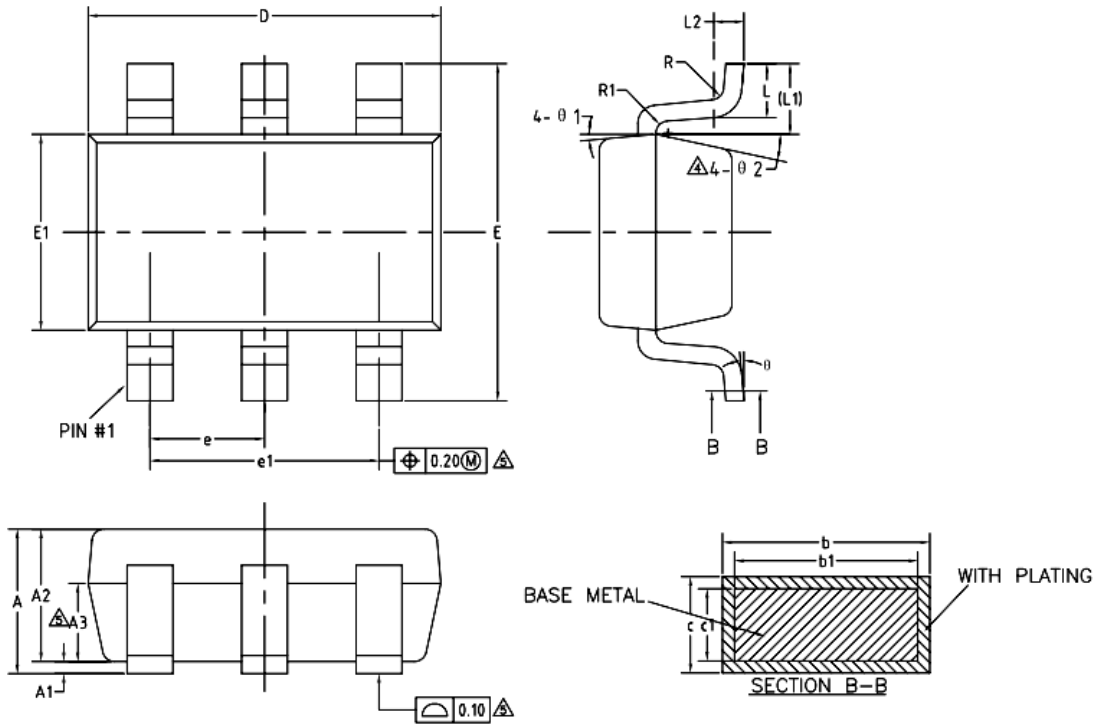

COMMON DIMENSIONS
(UNITS OF MEASURE=MILLIMETER)

SYMBOL	MIN	NOM	MAX
A	—	—	1.25
A1	0	—	0.15
A2	1.00	1.10	1.20
A3	0.60	0.65	0.70
b	0.36	—	0.50
b1	0.36	0.38	0.45
c	0.14	—	0.20
c1	0.14	0.15	0.16
D	2.826	2.926	3.026
E	2.60	2.80	3.00
E1	1.526	1.626	1.726
e	0.90	0.95	1.00
e1	1.80	1.90	2.00
L	0.35	0.45	0.60
L1	0.59REF		
L2	0.25BSC		
R	0.10	—	—
R1	0.10	—	0.20
θ	0°	—	8°
θ 1	3°	5°	7°
θ 2	6°	—	14°

DFN6

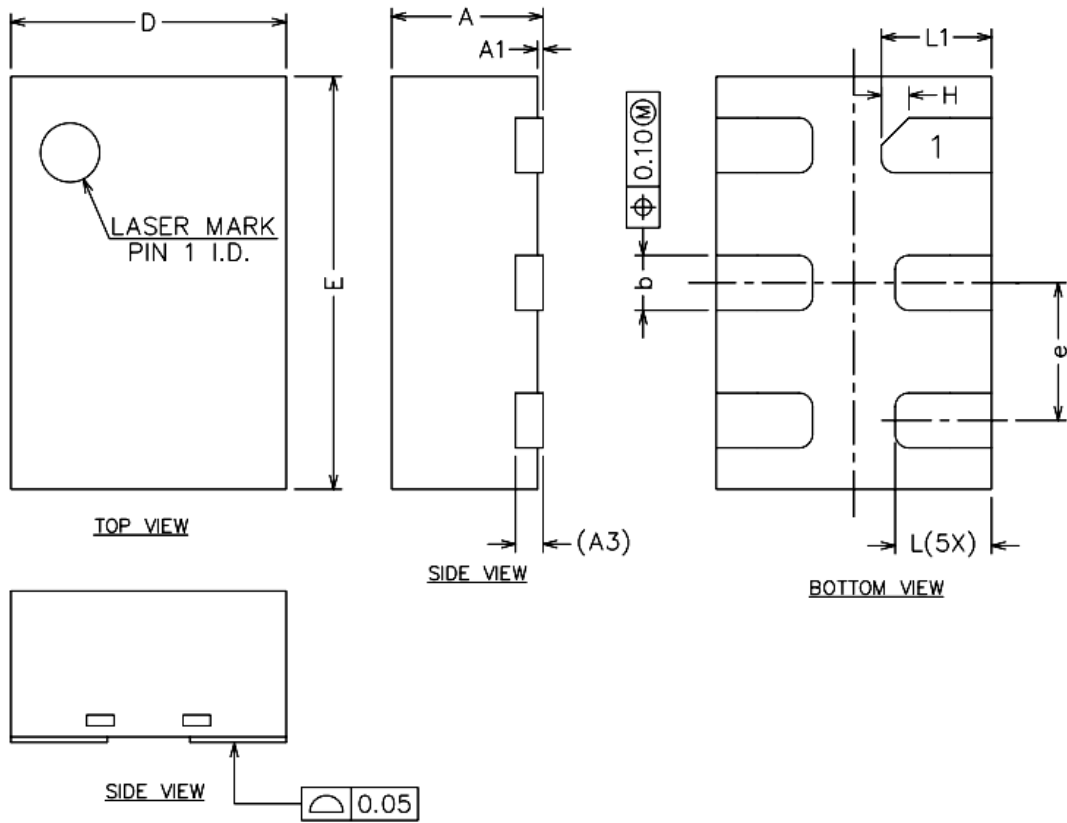

COMMON DIMENSIONS
(UNITS OF MEASURE=MILLIMETER)

SYMBOL	MIN	NOM	MAX
A	0.50	-	0.60
A1	0.00	0.02	0.05
A3	0.10REF		
b	0.15	0.20	0.25
D	0.90	1.00	1.10
E	1.40	1.50	1.60
e	0.40	0.50	0.60
H	0.10REF		
L	0.30	0.35	0.40
L1	0.35	0.40	0.45

Ordering information

Order code	Marking code	Package	Baseqty	Deliverymode
UMW SN74LVC2G34DBVR	C345	SOT23-6	3000	Tape and reel
UMW SN74LVC2G34DCKR	C9K	SC70-6	3000	Tape and reel
UMW SN74LVC2G34DRYR	C9	DFN6	3000	Tape and reel