

General Description

The IRFZ44NS/IRFZ44N uses advanced trench technology and design to provide excellent $R_{DS(ON)}$ with low gate charge. It can be used in a wide variety of applications.

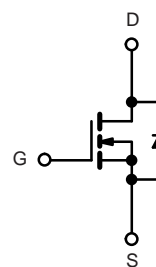

N-Channel MOSFET

Product Summary

V_{DS}	60V
I_D (at $V_{GS}=-10V$)	50A
$R_{DS(ON)}$ (at $V_{GS}=10V$)	< 12m Ω
$R_{DS(ON)}$ (at $V_{GS}=4.5V$)	< 16m Ω

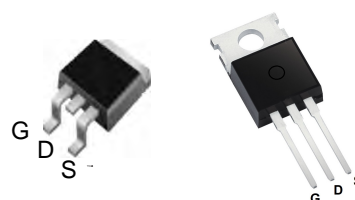

Absolute Maximum Ratings(TA=25°C unless otherwise noted)

Parameter		Symbol	Value	Unit
Drain-Source Voltage		V_{DS}	60	V
Gate-Source Voltage		V_{GS}	± 20	V
Drain Current-Continuous ^{Note3}	TC=25°C	I_D	50	A
	TC=100°C		33	A
Drain Current-Pulsed ^{Note1}		I_{DM}	200	A
Avalanche Energy ^{Note4}		E_{AS}	64	mJ
Maximum Power Dissipation	TC=25°C	P_D	105	W
Storage Temperature Range		T_{STG}	-55 to +150	°C
Operating Junction Temperature Range		T_J	-55 to +150	°C

Thermal Resistance

Parameter	Symbol	Min.	Typ.	Max	Unit
Thermal Resistance, Junction-to-Case	$R_{\theta JC}$	-	-	1.4	°C/W

Electrical Characteristics(T_J=25°C unless otherwise noted)

OFF CHARACTERISTICS						
Parameter	Symbol	Conditions	Min.	Typ.	Max.	Unit
Drain-Source Breakdown Voltage	BV _{DSS}	V _{GS} =0V, I _{DS} =250uA	60	-	-	V
Zero Gate Voltage Drain Current	I _{DSS}	V _{DS} =60V, V _{GS} =0V	-	-	1.0	uA
Gate-Body Leakage	I _{GSS}	V _{GS} =±20V, V _{DS} =0V	-	-	±100	nA

ON CHARACTERISTICS						
Parameter	Symbol	Conditions	Min.	Typ.	Max.	Unit
Gate Threshold Voltage	V _{GS(TH)}	V _{DS} =V _{GS} , I _{DS} =250uA	1.0	1.6	2.5	V
Drain-Source On-State Resistance	R _{DS(ON)}	V _{GS} =10V, I _{DS} =30A	-	12	17	mΩ
		V _{GS} =4.5V, I _{DS} =20A	-	16	21	mΩ

DYNAMIC CHARACTERISTICS						
Parameter	Symbol	Conditions	Min.	Typ.	Max.	Unit
Input Capacitance	C _{ISS}	V _{DS} =25V, V _{GS} = 0V, f=1MHz	-	2928	-	pF
Output Capacitance	C _{OSS}		-	141	-	
Reverse Transfer Capacitance	C _{rss}		-	120	-	

SWITCHING CHARACTERISTICS						
Parameter	Symbol	Conditions	Min.	Typ.	Max.	Unit
Turn-On Delay Time	T _{d(on)}	V _{GS} =10V, V _{DS} =30V, R _{GEN} =1.8Ω I _D =25A	-	7.5	-	ns
Rise Time	t _r		-	6.0	-	
Turn-Off Delay Time	T _{d(off)}		-	28.4	-	
Fall Time	t _f		-	5.5	-	
Total Gate Charge at 10V	Q _g	V _{DS} =30V, I _{DS} =25A, V _{GS} =10V	-	50	-	nC
Gate to Source Gate Charge	Q _{gs}		-	6	-	
Gate to Drain "Miller" Charge	Q _{gd}		-	15	-	

DRAIN-SOURCE DIODE CHARACTERISTICS AND MAXIMUM RATINGS						
Parameter	Symbol	Conditions	Min.	Typ.	Max.	Unit
Drain-Source Diode Forward Voltage	V _{SD}	V _{GS} =0V, I _{DS} =30A	-	-	1.2	V
Reverse Recovery Time	t _{rr}	T _J =25°C, I _F =25A di/dt=100A/us	-	29	-	nS
Reverse Recovery Charge	Q _{rr}		-	42	-	nC

Notes:

- 1: Repetitive rating, pulse width limited by maximum junction temperature.
- 2: Surface mounted on FR4 Board, t_s≤10sec.
- 3: Pulse width ≤ 300μs, duty cycle ≤ 2%.
- 4: EAS condition: L=0.5mH, V_{DD}=10V, V_G=10V, V_{GATE}=20V, Start T_J=25°C.

TYPICAL CHARACTERISTICS (25 °C unless noted)

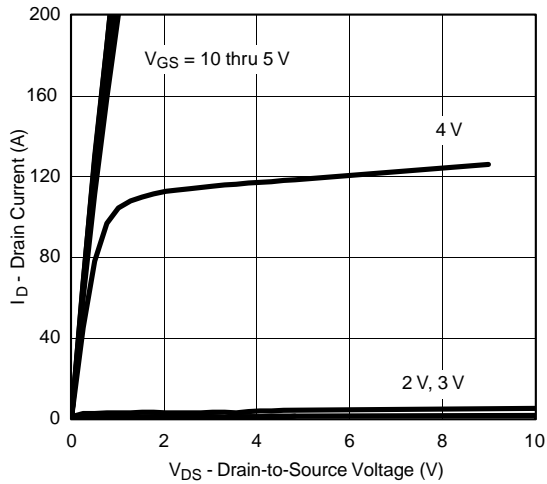

Output Characteristics

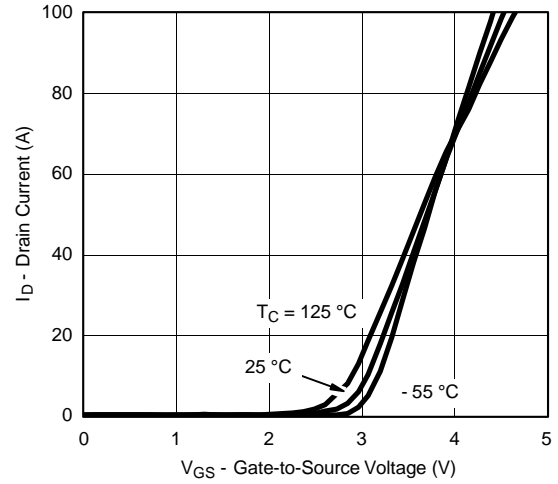

Transfer Characteristics

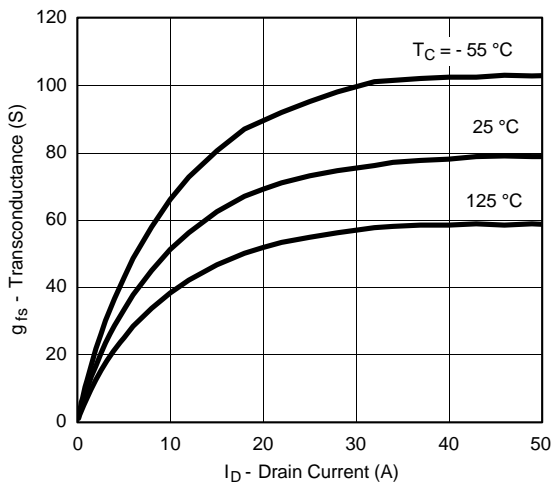

Transconductance

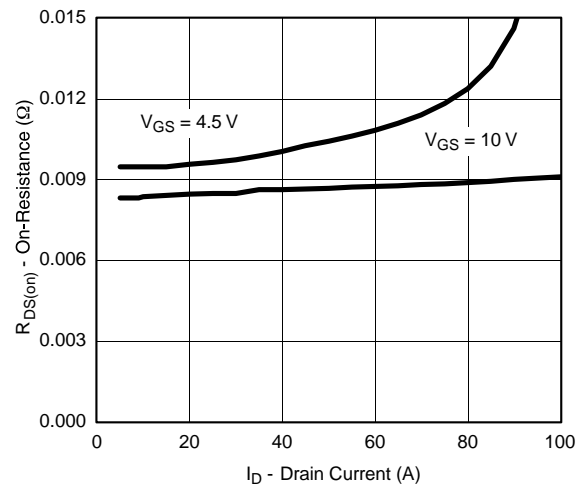

On-Resistance vs. Drain Current

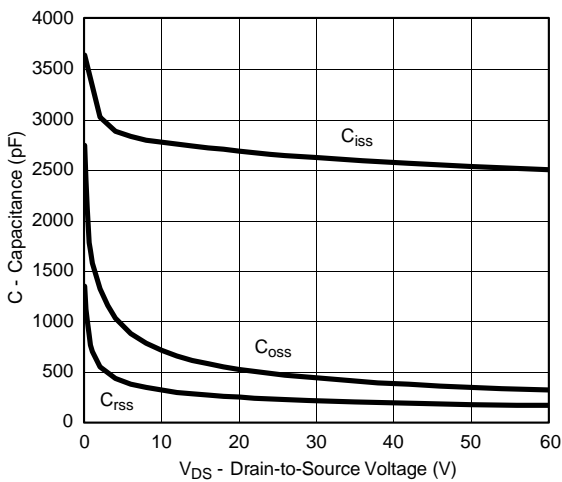

Capacitance

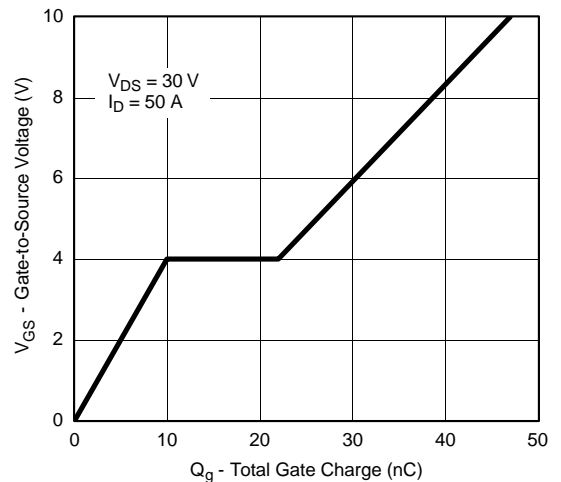

Gate Charge

TYPICAL CHARACTERISTICS (25 °C unless noted)

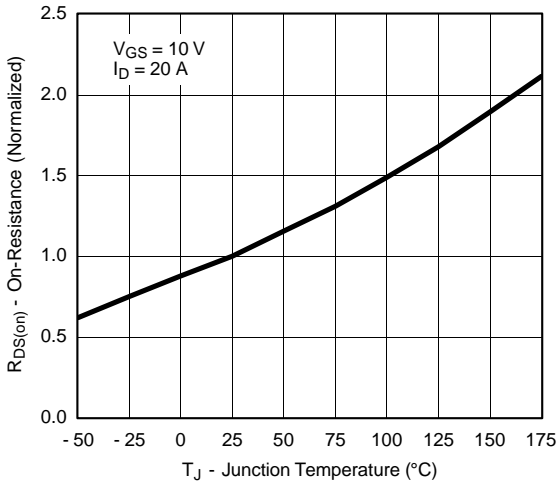

On-Resistance vs. Junction Temperature

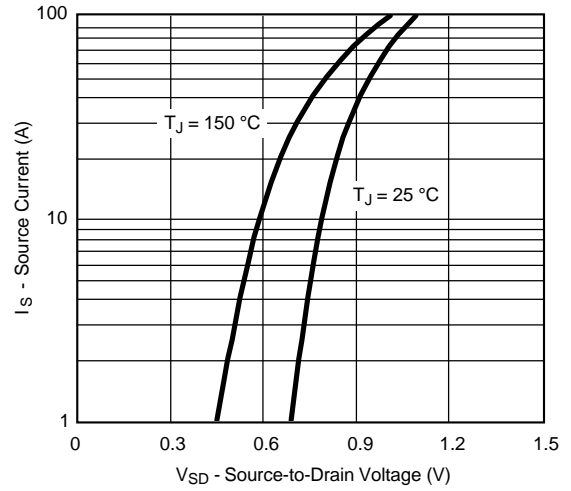

Source-Drain Diode Forward Voltage

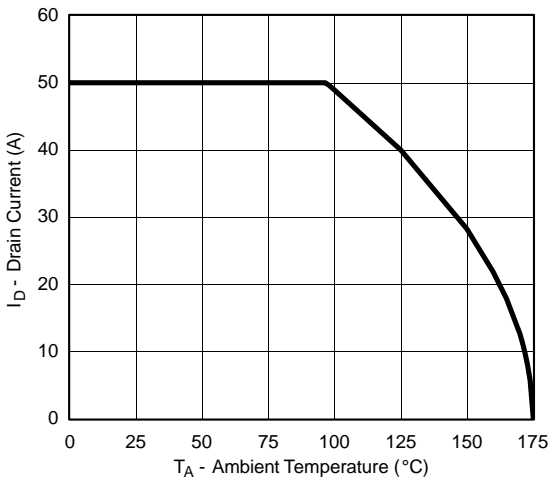

Maximum Drain Current vs. Ambient Temperature

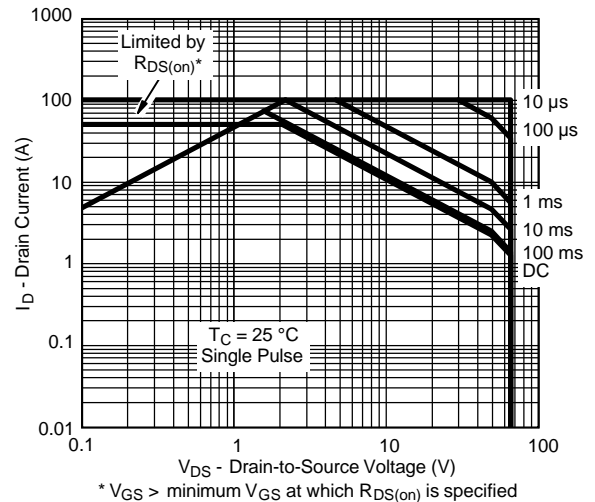

Safe Operating Area

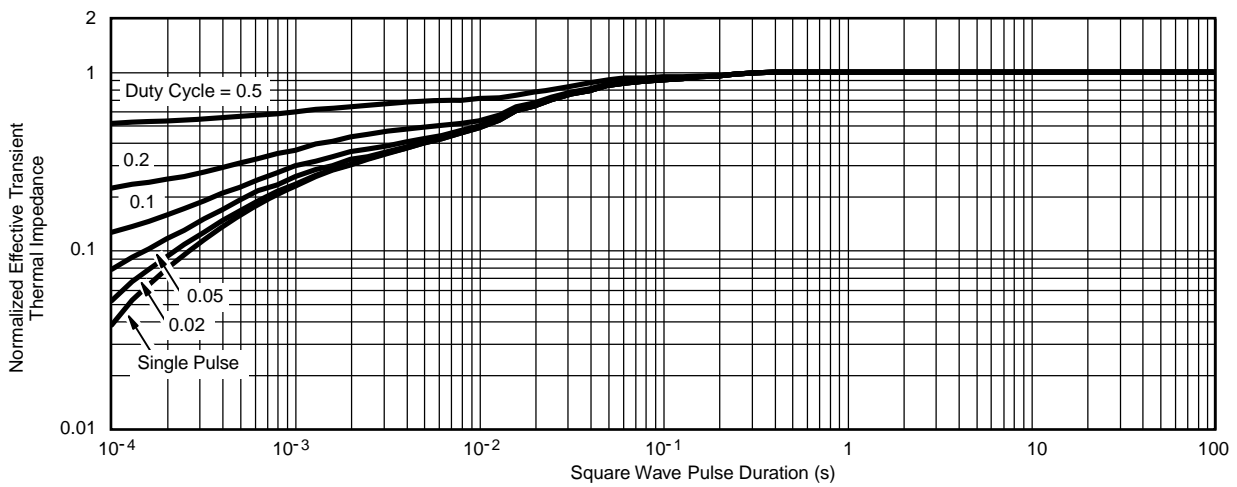

Normalized Thermal Transient Impedance, Junction-to-Case

Test Circuit

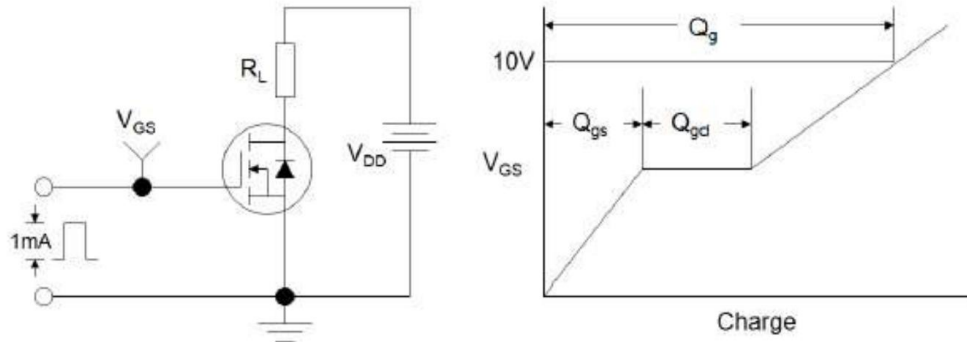

Figure 1: Gate Charge Test Circuit & Waveform

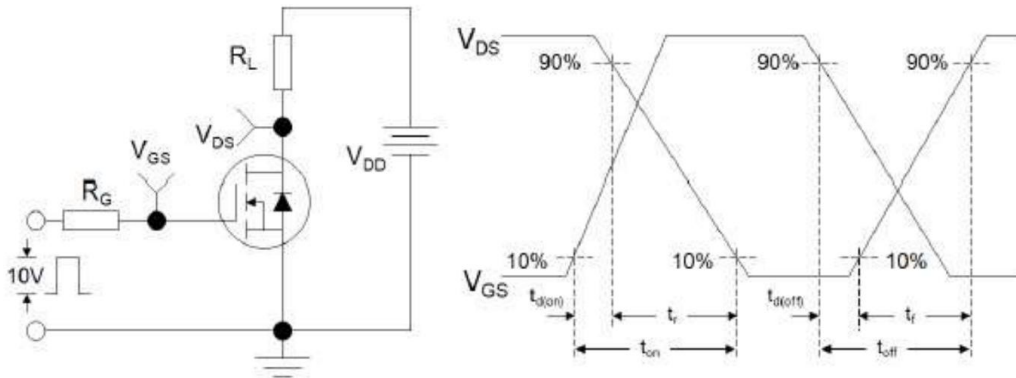

Figure 2: Resistive Switching Test Circuit & Waveforms

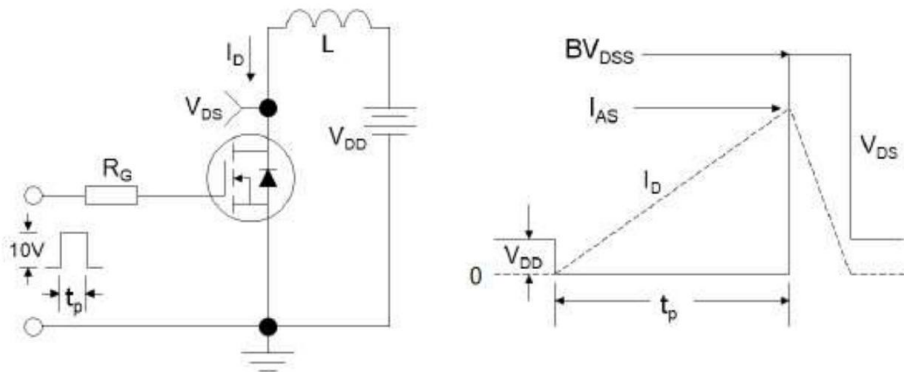
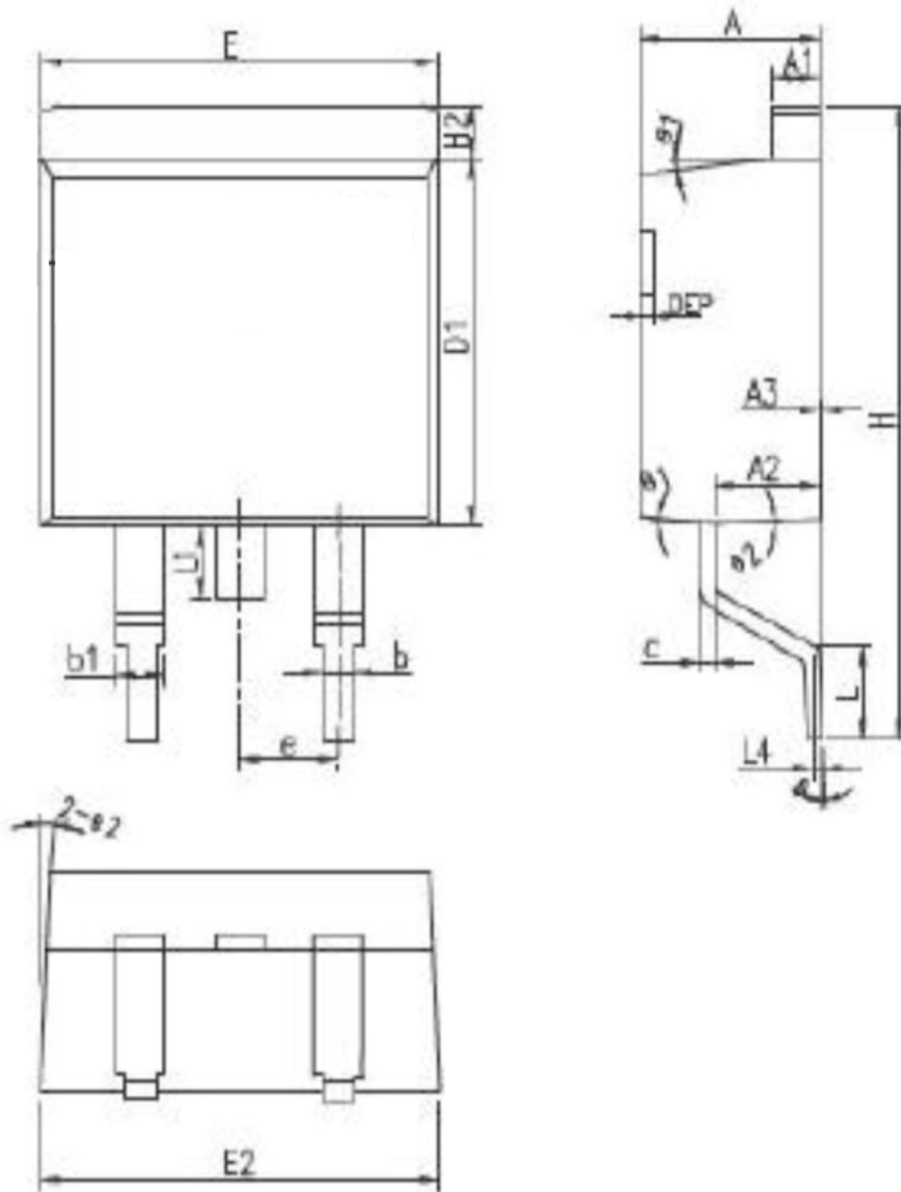

Figure 3: Unclamped Inductive Switching Test Circuit & Waveforms

PACKAGES DIMENSION : TO-263



Symbol	Inches			Millimeters		
	Min	Nom	Max	Min	Nom	Max
A	4.40	4.57	4.57	0.173	0.180	0.185
A1	1.22	1.27	1.27	0.048	0.050	0.052
A2	2.59	2.69	2.69	0.102	0.106	0.110
A3	0.00	0.10	0.10	0.000	0.004	0.008
b	0.77	0.813	0.813	0.030	0.032	0.035
b1	1.20	1.270	1.270	0.047	0.050	0.054
c	0.34	0.381	0.381	0.013	0.015	0.019
D1	8.60	8.70	8.99	0.339	0.343	0.354
E	10.00	10.16	10.16	0.394	0.400	0.404
E2	10.00	10.10	10.10	0.394	0.398	0.402
e	2.54BSC			0.100BSC		
H	14.70	15.10	15.50	0.579	0.594	0.610
H2	1.17	1.27	1.40	0.046	0.050	0.055
L	2.00	2.30	2.60	0.079	0.091	0.102
L1	1.45	1.55	1.70	0.057	0.061	0.067
L4	0.25BSC			0.010BSC		
theta	0°	5°	8°	0°	5°	8°
theta1	5°	7°	9°	5°	7°	9°
theta2	1°	3°	5°	1°	3°	5°
DEP	0.05	0.10	0.20	0.002	0.004	0.008

PACKAGES DIMENSION : TO-220

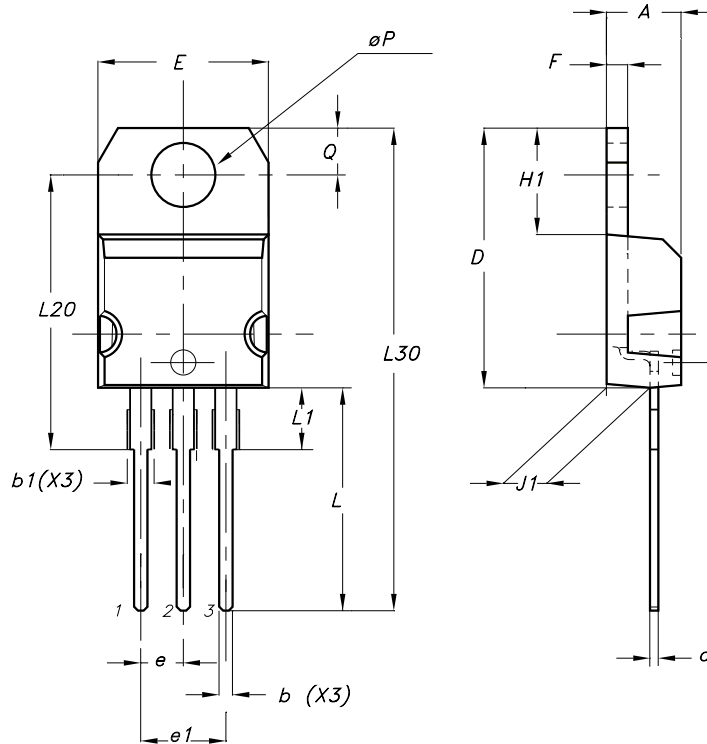

DIM.	mm.			inch		
	MIN.	TYP	MAX.	MIN.	TYP.	MAX.
A	4.40		4.60	0.173		0.181
b	0.61		0.88	0.024		0.034
b1	1.15		1.70	0.045		0.067
c	0.49		0.70	0.019		0.027
D	15.25		15.75	0.600		0.620
E	10.0		10.40	0.393		0.409
e	2.4		2.7	0.094		0.106
e1	4.95		5.15	0.194		0.203
F	1.23		1.32	0.048		0.051
H1	6.2		6.6	0.244		0.260
J1	2.40		2.72	0.094		0.107
L	13.0		14.0	0.511		0.551
L1	3.5		3.93	0.137		0.154
L20		16.4			0.645	
L30		28.9			1.138	
φP	3.75		3.85	0.147		0.151
Q	2.65		2.95	0.104		0.116

Ordering information

Order code	Package	Baseqty	Deliverymode
UMW IRFZ44NS	TO-263	800	Tape and reel
UMW IRFZ44N	TO-220	1000	Tube and box