

Description

TVS diodes are characterized by their high surge capability, low operating and clamping voltages, and fast response time. This makes them ideal for use as board level protection of sensitive semiconductor components. The low profile SOT-23 package allows flexibility in the design of crowded circuit boards.

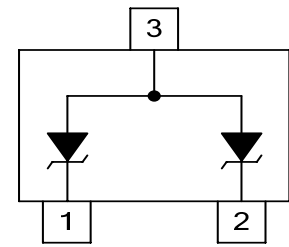

Pin Configuration

Features

- IEC61000-4-2 ESD 15KV Air, 8KV contact compliance
- SOT-23 surface mount package
- Protects one bidirectional line or two unidirectional lines
- Working voltage: 3.3V, 5V, 12V, 15V, 24V and 36V
- Low leakage current
- Low operating and clamping voltages
- Solid-state silicon avalanche technology
- Lead Free/RoHS compliant
- Solder reflow temperature: Pure Tin-Sn, 260~270 °C
- Flammability rating UL 94V-0
- Meets MSL level 1, per J-STD-020

Applications

- Cellular handsets and accessories
- Personal digital assistants (PDA's)
- Portable instrumentation
- Set Top Box (STB)
- Servers, notebook, and desktop PC
- Wireless bus protection
- RS-232, RS-422, RS-423 protection

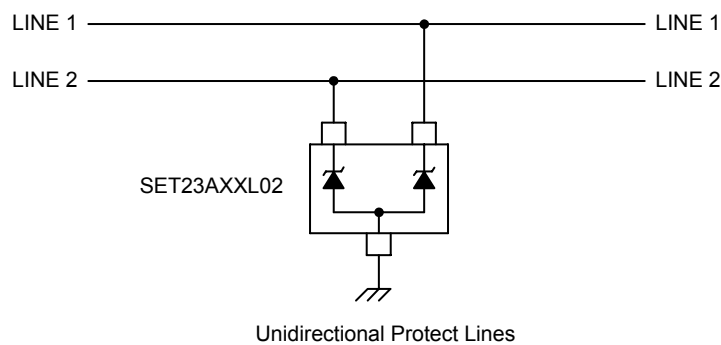
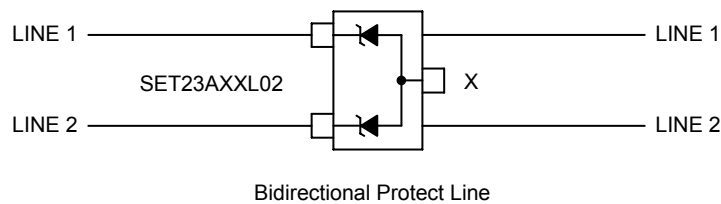

Electrical Characteristics (T_J=25°C)

Rating	Symbol	Value	Unit
ESD voltage (Contact discharge)	V _{ESD}	±8	kV
ESD voltage (Air discharge)		±15	
Storage & operating temperature range	T _{STG} , T _J	-55~+150	°C

SET23A03L02

Parameter	Symbol	Condition	Min.	Typ.	Max.	Unit
Reverse stand-off voltage	V _{RWM}				3.3	V
Reverse breakdown voltage	V _{BR}	I _{BR} =1mA	4			V
Reverse leakage current	I _R	V _R =3.3V Each I/O pin			5	μA
Clamping voltage (tp=8/20μs)	V _C	I _{PP} =1A			7.5	V
Clamping voltage (tp=8/20μs)	V _C	I _{PP} =10A			15	V
Off state junction capacitance	C _J	0Vdc, f=1MHz Between I/O pins and GND		200		pF

SET23A05L02

Parameter	Symbol	Condition	Min.	Typ.	Max.	Unit
Reverse stand-off voltage	V _{RWM}				5	V
Reverse breakdown voltage	V _{BR}	I _{BR} =1mA	6			V
Reverse leakage current	I _R	V _R =5V Each I/O pin			5	μA
Clamping voltage (tp=8/20μs)	V _C	I _{PP} =1A			9.8	V
Clamping voltage (tp=8/20μs)	V _C	I _{PP} =15A			20	V
Off state junction capacitance	C _J	0Vdc, f=1MHz Between I/O pins and GND		220		pF

Electrical Characteristics (T_J=25 °C)

SET23A12L02

Parameter	Symbol	Condition	Min.	Typ.	Max.	Unit
Reverse stand-off voltage	V _{RWM}				12	V
Reverse breakdown voltage	V _{BR}	I _{BR} =1mA	13.3			V
Reverse leakage current	I _R	V _R =12V Each I/O pin			1	μA
Clamping voltage (tp=8/20μs)	V _C	I _{PP} =1A			19	V
Clamping voltage (tp=8/20μs)	V _C	I _{PP} =10A			25.9	V
Off state junction capacitance	C _J	0Vdc, f=1MHz Between I/O pins and GND		100		pF

SET23A15L02

Parameter	Symbol	Condition	Min.	Typ.	Max.	Unit
Reverse stand-off voltage	V _{RWM}				15	V
Reverse breakdown voltage	V _{BR}	I _{BR} =1mA	16.7			V
Reverse leakage current	I _R	V _R =15V Each I/O pin			1	μA
Clamping voltage (tp=8/20μs)	V _C	I _{PP} =1A			24	V
Clamping voltage (tp=8/20μs)	V _C	I _{PP} =10A			30	V
Off state junction capacitance	C _J	0Vdc, f=1MHz Between I/O pins and GND		90		pF

SET23A24L02

Parameter	Symbol	Condition	Min.	Typ.	Max.	Unit
Reverse stand-off voltage	V _{RWM}				24	V
Reverse breakdown voltage	V _{BR}	I _{BR} =1mA	26.7			V
Reverse leakage current	I _R	V _R =24V each I/O pin			1	μA
Clamping voltage (tp=8/20μs)	V _C	I _{PP} =1A			43	V
Clamping voltage (tp=8/20μs)	V _C	I _{PP} =5A			49	V
Off state junction capacitance	C _J	0Vdc, f=1MHz Between I/O pins and GND		80		pF

Electrical Characteristics (T_J=25 °C)

SET23A36L02

Parameter	Symbol	Condition	Min.	Typ.	Max.	Unit
Reverse stand-off voltage	V _{RWM}				36	V
Reverse breakdown voltage	V _{BR}	I _{BR} =1mA	40			V
Reverse leakage current	I _R	V _R =36V each I/O pin			1	μA
Clamping voltage (tp=8/20μs)	V _C	I _{PP} =1A			51	V
Clamping voltage (tp=8/20μs)	V _C	I _{PP} =5A			76.8	V
Off state junction capacitance	C _J	0Vdc, f=1MHz Between I/O pins and GND		70		pF

Figure 1. Power Derating Curve

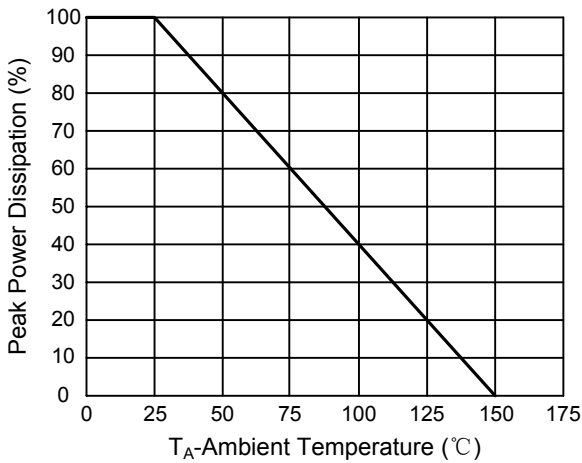

Figure 2. Pulse Waveforms

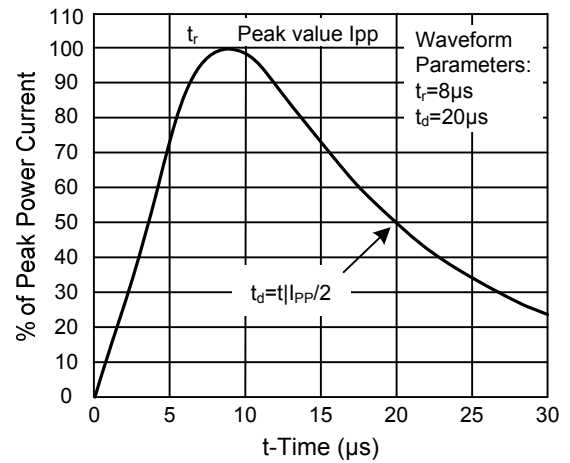

Figure 3. Forward Voltage vs. Forward Current

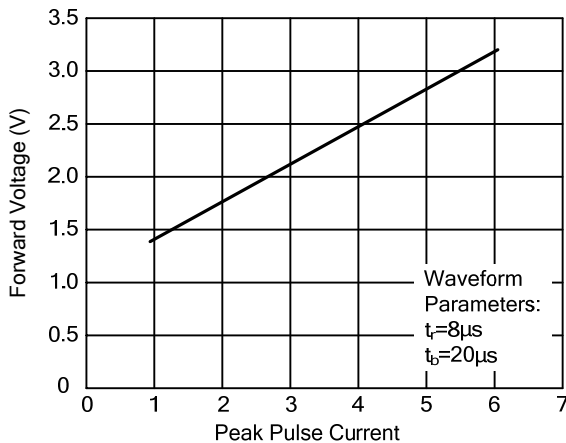
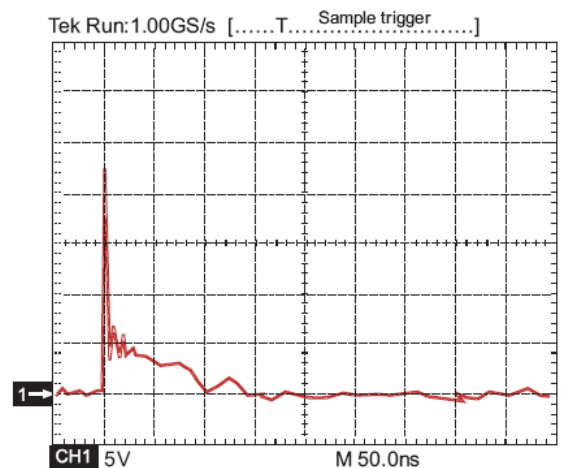
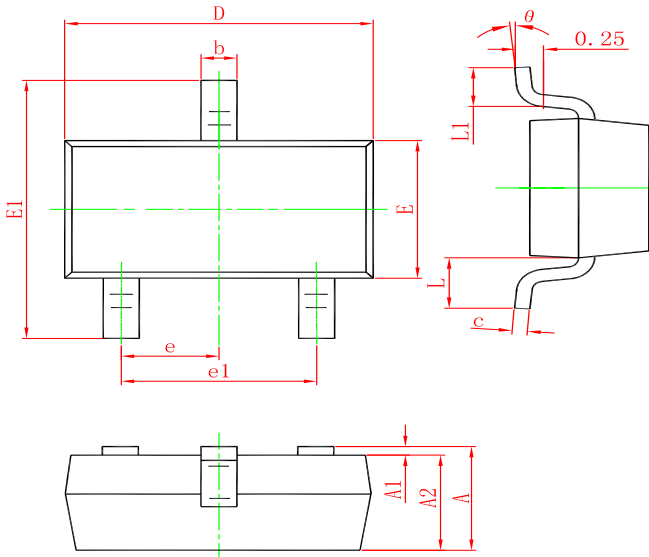

Figure 4. ESD Clamping(8kV Contact IEC61000-4-2)



SOT-23 PACKAGE OUTLINE DIMENSIONS



Symbol	Dimensions In Millimeters		Dimensions In Inches	
	Min.	Max.	Min.	Max.
A	0.900	1.150	0.035	0.045
A1	0.000	0.100	0.000	0.004
A2	0.900	1.050	0.035	0.041
b	0.300	0.500	0.012	0.020
c	0.080	0.150	0.003	0.006
D	2.800	3.000	0.110	0.118
E	1.200	1.400	0.047	0.055
E1	2.250	2.550	0.089	0.100
e	0.950 TYP.		0.037 TYP.	
e1	1.800	2.000	0.071	0.079
L	0.550 REF.		0.022 REF.	
L1	0.300	0.500	0.012	0.020
θ	0°	8°	0°	8°

Marking

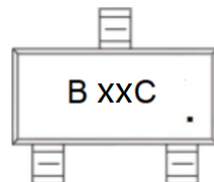

Ordering information

Order code	Package	Baseqty	Deliverymode	Marking
UMW SET23A03L02	SOT-23	3000	Tape and reel	B 03C
UMW SET23A05L02	SOT-23	3000	Tape and reel	B 05C
UMW SET23A12L02	SOT-23	3000	Tape and reel	B 12C
UMW SET23A15L02	SOT-23	3000	Tape and reel	B 15C
UMW SET23A24L02	SOT-23	3000	Tape and reel	B 24C
UMW SET23A36L02	SOT-23	3000	Tape and reel	B 36C